



MODEL 97XX-SERIES
CASH DISPENSER
OPERATION MANUAL

VERSION 2.0

TDN 07102-00042B 03/2003

CORPORATE HEADQUARTERS:

522 E. Railroad Street
Long Beach, MS 39560
PHONE: (228) 868-1317
FAX: (228) 868-0437

**RMA (RETURN MATERIAL AUTHORIZATION)
RETURN ADDRESS:**

21405 B Street
Long Beach, MS 39560

COPYRIGHT NOTICE

Copyright © Delaware Capital Formation, Inc., 2002, 2003. All rights reserved. No part of this publication may be reproduced, transmitted, transcribed, stored in a retrieval system, or translated into any human or computer language, in any form, by any means whatsoever, without the express written permission of Delaware Capital Formation, Inc. DOVER and the DOVER logo are registered trademarks of Delaware Capital Formation, Inc., a wholly-owned subsidiary of Dover Corporation.

DISCLAIMER

The manufacturer of the Cash Dispenser product(s) described herein makes no representations or warranties, either expressed or implied, by or with respect to anything in this manual, and shall not be liable for any implied warranties of fitness for a particular purpose or for any indirect, special or consequential damages. Information in this document is subject to change without notice and does not represent a commitment on the part of the manufacturer. **USE OF THIS PRODUCT IN A MANNER OTHER THAN THOSE DESCRIBED IN THIS MANUAL MAY RESULT IN PERSONAL INJURY.**

FCC COMPLIANCE

Statement of Compliance: This equipment complies with Part 68 of the FCC rules. Located in the control area of the ATM is the Product Label. This label lists the FCC registration number and ringer equivalence number of the unit. If requested, this information must be provided to the telephone company. At the time of this printing, the 97XX FCC Part 68 registration number was US:51KDT08B9700.

USCO/FIC Codes: When ordering service from the telephone company for the 97XX series Cash Dispenser, the following information should be supplied:

Universal Service Order Code (USOC): RJ-11C

The Facility Interface Code (FIC): 02LS2

Plug and Jack: The plug and jack used to connect this equipment to premise wiring and telephone network must comply with the applicable FCC Part 68 rules and requirements adopted by ACTA. A compliant telephone cord and modular plug is provided with this product. The telephone cord is designed to be connected to a compatible modular jack that is also compliant.

Ringer Equivalent Number (REN): The REN is used to determine the number of the devices that may be connected to a telephone line. Excessive RENs on a telephoneline may result in the devices not ringing in response to an incoming call. In most but not all areas, the sum of the RENs should not exceed five (5). To be certain of the number devices that may be connected to a line, as determined by the local RENs, contact the local telephone company.

Harm to the Network: If the 97XX series Cash Dispenser causes harm to the telephone network, the telephone company will notify the customer that a temporary discontinuous of service may be required. If advanced notice is not possible, the telephone company will notify the customer as soon as possible. You will be advised of your right to file a complaint with the FCC if you believe it's necessary.

Notification of Changes in Telephone Company Equipment: The telephone company may make changes in its facilities, equipment, operations or procedures that could affect the operation of the equipment. If this happens, the telephone company will provide advanced notice in order for you to make necessary modifications to maintain uninterrupted service.

Repairs and Returns: If telecom compatibility trouble is experienced with the Model 97XX series Cash Dispenser, you may contact for repairs and warranty information: Triton at 1-228-868-1317

Triton Systems of Delaware, Inc.
522 East Railroad Street
Long Beach, MS 39560

If the equipment is causing harm to the network, the telephone company may request that you disconnect the equipment until the problem is resolved. Repairs should be made only by qualified factory representatives.

Party Lines: The Model 97XX series Cash Dispenser must not be used on party lines.

Alarm Equipment: The Model 97XX series Cash Dispenser should have its own dedicated phone line. Do not install the 97XX on the same line as alarm equipment.

Electrical Safety Advisory: telephone companies report that electrical surges, typically lightening transients, are very destructive to customer equipment connected to AC power sources. This has been identified as a major nationwide problem. A commercially available, power surge suppressor, is recommended for use with the Model 97Xx to minimize damage in the event of an electrical surge.

CANADIAN IC COMPLIANCE

NOTICE:

The Industry Canada label identifies certified equipment. This certification means that the equipment meets telecommunications network protective, operational and safety requirements as prescribed in the appropriate Terminal Equipment Technical Requirements document(s). The Department does not guarantee the equipment will operate to the user's satisfaction.

Before installing this equipment, users should ensure that it is permissible to be connected to the facilities of the local telecommunications company. The equipment must also be installed using an acceptable method of connection. The customer should be aware that compliance with the above conditions may not prevent degradation of service in some situations.

Repairs to certified equipment should be coordinated by a representative designated by the supplier. Any repairs or alterations made by the user to this equipment, or equipment malfunctions, may give the telecommunications company cause to request the user to disconnect the equipment.

Users should ensure for their own protection that the electrical ground connections of the power utility, telephone lines and internal metallic water pipe system, if present, are connected together. This precaution may be particularly important in rural areas. Caution: Users should not attempt to make such connections themselves, but should contact the appropriate electric inspection authority, or electrician, as appropriate.

NOTICE:

The Ringer Equivalence Number (REN) assigned to each terminal device provides an indication of the maximum number of terminals allowed to be connected to a telephone interface. The termination on an interface may consist of any combination of devices subject only to the requirement that the sum of the Ringer Equivalence Numbers of all the devices does not exceed 5.

AVIS:

L'étiquette d'Industrie Canada identifie le matériel homologué. Cette étiquette certifie que le matériel est conforme aux normes de protection, d'exploitation et de sécurité des réseaux de télécommunications, comme le prescrivent les documents concernant les exigences techniques relatives au matériel terminal. Le Ministère n'assure toutefois pas que le matériel fonctionnera à la satisfaction de l'utilisateur.

Avant d'installer ce matériel, l'utilisateur doit s'assurer qu'il est permis de le raccorder aux installations de l'entreprise locale de télécommunication. Le matériel doit également être installé en suivant une méthode acceptée de raccordement. L'abonné ne doit pas oublier qu'il est possible que la conformité aux conditions énoncées ci-dessus n'empêche pas la dégradation du service dans certaines situations.

Les réparations de matériel homologué doivent être coordonnées par un représentant désigné par le fournisseur. L'entreprise de télécommunications peut demander à l'utilisateur de débrancher un appareil à la suite de réparations ou de modifications effectuées par l'utilisateur ou à cause de mauvais fonctionnement.

Pour sa propre protection, l'utilisateur doit s'assurer que tous les fils de mise à la terre de la source d'énergie électrique, des lignes téléphoniques et des canalisations d'eau métalliques, s'il y en a, sont raccordés ensemble. Cette précaution est particulièrement importante dans les régions rurales. Avertissement: L'utilisateur ne doit pas tenter de faire ces raccordements lui-même; il doit avoir recours à un service d'inspection des installations électriques, ou à un électricien, selon le cas.

AVIS:

L'indice d'équivalence de la sonnerie (IES) assigné à chaque dispositif terminal indique le nombre maximal de terminaux qui peuvent être raccordés à une interface. La terminaison d'une interface téléphonique peut consister en une combinaison de quelques dispositifs, à la seule condition que la somme d'indices d'équivalence de la sonnerie de tous les dispositifs n'exède pas 5.

UNITED KINGDOM

This equipment has been approved in accordance with Council Decision 98/482/EC for pan-European single terminal connection to the public switched telephone network (PSTN). However, due to differences between the individual PSTNs provided in the different countries, the approval does not, of itself, give unconditional assurance of successful operation on every PSTN network termination point. In the event of problems, contact your equipment supplier in the first instance. This unit uses only DTMF address signaling.

EMISSIONS (EMI)

This device complies with Part 15 of the FCC rules. Operation is subject to the following two (2) conditions:

- 1) This device may not cause harmful interference.
- 2) This device must accept any interference received, including interference that may cause undesired operation.

Note:

This equipment has been tested and found to comply with the limits for a Class A digital device, pursuant to Part 15 of FCC Rules. These limits are designed to provide reasonable protection against harmful interference when the equipment is operated in a commercial environment. This equipment generates, uses, and can radiate radio frequency energy and, if not installed and used in accordance with the instruction manual, may cause harmful interference to radio communications. Operation of this equipment in a residential area is likely to cause harmful interference in which case the user will be required to correct the interference at his own expense. Changes or modifications to this unit not expressly approved by the party responsible for compliance could void the user's authority to operate the equipment.

CANADIAN EMISSION REQUIREMENTS

This digital apparatus does not exceed the Class A limits for radio noise emissions from digital apparatus set in the Radio Interference Regulations of the Canadian Department of Communications. This Class A digital apparatus complies with Canadian ICES-003.

Le present appareil numerique n'emet pas de bruits radioelectriques dépassant les limites applicables aux appareils numeriques de la Class A prescrites dans le Reglement sur le brouillage radioelectrique edicte par le ministere des Communications du Canada. Cet appareil numerique de la classe A est conforme a la norme NMB-003 Canada.

UK / AUSTRALIAN EMISSION REQUIREMENTS

Warning:

This is a Class A product. In a domestic environment this product may cause radio interference in which case the user may be required to take adequate measures.

Contents

SECTION 1 - INTRODUCTION	1-1
What's in This Manual	1-2
Cash Dispenser Families	1-2
Class of Service (Business-vs-Level 1)	1-2
Security Vault Access (Front-vs-Rear)	1-2
Feature Highlights	1-3
Standard Features	1-4
256-Color Display	1-4
Selectable Background Screen-Graphic	1-4
Voice-Enabled Transactions	1-4
MAC Data Encryption Support	1-4
SPED PIN Entry Device Support	1-4
DATAPAK 3000 Communications Protocol Support	1-5
Close Scheduling	1-5
Exit Message	1-5
Predial Capability	1-5
Alarm Thresholds	1-5
Transaction and Account Type Configuration	1-6
Electronic Journal	1-6
Distributor EPROM Access With Challenge	1-7
Status Monitoring	1-7
Language Option	1-7
International Monetary Support	1-7
Six-Digit Amount Entry Fields	1-7
Receipt Printer Paper Low Option	1-7
AD Screens	1-8
Text-Based AD Screens	1-8
Receipt Printer Graphics	1-8
Prize Coupons Option	1-8
Receipt Option	1-9
Triton Connect	1-9
Extended Amounts	1-10
Date/Time Format	1-10
Dispense Counter	1-10
 SECTION 2 - BASIC OPERATION	 2-1
Introduction	2-2
Menu-based Operation	2-2
Keypad Operation	2-3
Accessing Management Functions	2-5
 SECTION 3 - INITIAL SETUP	 3-1
Cash Dispenser Parameter Categories	3-2
Parameter Importance Levels	3-3
Cash Dispenser Setup Parameters	3-4

SECTION 4 - CURRENCY HANDLING	4-1
New or Uncirculated Note Defects	4-3
Preparing Notes	4-3
Preparing Used Notes	4-3
Preparing New or Uncirculated Notes	4-3
MODEL 9700-SERIES	4-4
Replenishing Cassettes	4-4
MODEL 9705-SERIES	4-7
Removing the Currency Cassette	4-7
Loading the Currency Cassette	4-8
Removing the Reject Cassette	4-10
Reinstalling the Dispenser Mechanism	4-11
MODEL 9710-SERIES	4-12
Removing the Note Tray	4-12
Removing Rejected Notes	4-12
Loading the Note Tray	4-12
MODEL 9750-SERIES	4-15
Removing Note Cassettes	4-15
Opening Note Cassettes	4-15
Loading Note Cassettes	4-16
Installing Note Cassettes	4-17
Removing the Reject Vault	4-17
Opening the Reject Vault	4-18
Closing the Reject Vault	4-18
Installing the Reject Vault	4-18
Verify Operation	4-19
SECTION 5 - MANAGEMENT FUNCTIONS	5-1
Introduction	5-2
Accessing the Management Functions Menu	5-2
Function Availability	5-2
MANAGEMENT FUNCTIONS	5-4
CLOSE	5-5
SCHEDULE CLOSE	5-6
CHANGE SCHEDULE	5-7
SEND TERMINAL TOTALS	5-8
TRIAL CLOSE	5-9
DAY CLOSE	5-10
CASSETTE CLOSE	5-11
TRIAL CASSETTE CLOSE	5-12
CASSETTE CLOSE	5-13
ENTER QTY. IN CASSETTE	5-14
SELECT CASSETTE	5-15
TRIAL CASSETTE CLOSE (ALL)	5-16
DIAGNOSTICS	5-17
STATUS	5-18
PURGE	5-20
TEST DISPENSE	5-21

CASH DISPENSER OPERATION MANUAL - MODEL 97XX-SERIES

FORMAT GRAPHIC MEMORY	5-22
TEST RECEIPT PRINTER	5-23
VERSION #'S	5-24
MORE DIAGNOSTICS	5-25
INJECT NEW CASSETTE ID	5-26
RESET/TEST MODEM	5-27
FORCE UNLOCK CASSETTE	5-28
SCAN CARD	5-30
LANGUAGE/IDIOMA	5-31
ENGLISH/INGLES	5-32
SPANISH/ESPANOL	5-33
ENABLE/DISABLE CUST. OPTION	5-34
JOURNAL	5-35
PRINT JOURNAL	5-36
CLEAR JOURNAL	5-37
PRINT LAST X ENTRIES	5-38
CASSETTE SERVICE	5-39
PASSWORD MAINTENANCE	5-40
MASTER PASSWORD	5-41
ADMINISTRATION PASSWORD	5-42
TERMINAL CONFIGURATION	5-43
PRINTER SETTINGS	5-44
SET PRINT LENGTH	5-45
LOW RECEIPT PAPER	5-46
PRINTER GRAPHICS	5-47
RANDOM/LEVEL PRIZE COUPONS	5-48
PRINTED COUPONS	5-49
ENTER LEVEL PRIZE MSG.	5-50
ENTER RANDOM PRIZE MSG.	5-51
ENABLE/DISABLE COUPON AWARDS	5-52
SET LEVEL PRIZE AMOUNT	5-53
SET RANDOM WINNING %	5-54
DISPENSED COUPONS	5-55
SELECT LEVEL COUPON CASS.	5-56
SELECT RANDOM COUPON CASS.	5-57
ENABLE/DISABLE COUPON AWARDS	5-58
SET LEVEL PRIZE AMOUNT	5-59
SET RANDOM WINNING %	5-60
CHANGE MESSAGES	5-61
MARKETING MESSAGE	5-62
SURCHARGE MESSAGES	5-63
WELCOME MESSAGE	5-65
SURCHARGE OWNER	5-66
EXIT MESSAGE	5-67
STORE MESSAGE	5-68
TERMINAL OWNER	5-69
TERMINAL PARAMETERS	5-70
SET TERMINAL #	5-71
RESET SEQ #	5-72

CASH DISPENSER OPERATION MANUAL - MODEL 97XX-SERIES

SURCHARGE MODE	5-73
SURCHARGE PERCENT	5-74
ENABLE/DISABLE SURCHARGE	5-75
SURCHARGE LOCATION	5-76
BLOCK ISO'S	5-77
SURCHARGE AMOUNT	5-79
CASSETTE SETUP	5-80
RELEARN BILL THICKNESS	5-81
LOW CURRENCY	5-82
INTERNATIONAL CURRENCY	5-83
MAXIMUM AMOUNT	5-84
MULTIPLE AMOUNT	5-85
MAX NON-CASH	5-86
EXTENDED AMOUNT	5-87
CASSETTE PARAMETERS	5-88
SET BILL DIMENSION	5-89
VALUE	5-90
TYPE	5-91
SERVICE	5-92
CURRENCY DATA	5-93
CASSETTE	5-95
DESCRIPTION	5-96
PRIMARY DESCRIPTION	5-97
SECONDARY DESCRIPTION	5-98
FAST CASH AMOUNT	5-99
KEY MANAGEMENT	5-100
ENTER MAC MASTER KEY	5-101
ENTER PIN MASTER KEY	5-103
INJECT MASTER KEYS	5-105
ENTER MAC WORKING KEY	5-106
ENTER PIN WORKING KEY	5-108
DOWNLOAD WORKING KEYS	5-110
TELEPHONE	5-111
PRIMARY NUMBER	5-112
BACKUP NUMBER	5-113
DATAPAK ACCESS CODE	5-114
PREDIAL ON/OFF	5-115
COMPUSERVE ID	5-116
MODEM SETUP	5-117
DIAL MODE	5-118
DIAL RATE	5-119
BAUD RATE	5-120
MODEM SETUP STRING	5-121
RESET/TEST MODEM	5-122
MORE (TERMINAL PARAMETERS)	5-123
ADJUST CONTRAST	5-124
RECEIPT OPTION	5-125
TRITON CONNECT	5-126
PRIMARY NUMBER	5-127

BACKUP NUMBER	5-128
ALARM NUMBERS	5-129
PRIMARY ALARM NUMBER	5-130
BACKUP ALARM NUMBER	5-131
ENABLE/DISABLE CALL BACK	5-132
ENABLE/DISABLE TRITON CONNECT	5-133
ATM MONITORING	5-134
STATUS MONITORING	5-135
HEARTBEAT MESSAGE	5-136
AD SCREENS	5-139
COMMUNICATION HEADER	5-140
MORE (TERMINAL PARAMETERS)	5-141
ALARM THRESHOLDS	5-142
SET LOW CASH THRESHOLD	5-143
SET JOURNAL THRESHOLD	5-144
SET SCHEDULED JOURNAL	5-145
BACKGROUND GRAPHICS	5-146
VIEW/MODIFY OPTIONS	5-147
ACTIVATE	5-148
DEACTIVATE	5-149
SELECT FEATURE NUMBER	5-150
DATE / TIME FUNCTIONS	5-151
SET DATE FORMAT	5-152
SET DATE / TIME	5-153
SET DATE	5-154
SET TIME	5-155
TRANSACTION TYPES	5-156
ACCOUNT TYPES	5-157
SECTION 6 - MAINTENANCE	6-1
Introduction	6-2
Replenishing the Receipt Paper	6-2
Cleaning the Enclosure	6-4
Cleaning the Display	6-4
Card Reader Cleaning	6-4
Card Reader Problems	6-5
Communication Problems	6-6
SECTION 7 - JOURNAL ENTRIES	7-1
Journal Entries	7-2
SECTION 8 - ERROR RECOVERY	8-1
Resetting the Cash Dispenser	8-3
Miscellaneous Error Codes	8-3
SECTION 9 - CUSTOMER TRANSACTIONS	9-1
Introduction	9-2
Customer Transactions	9-2
Voice-Enabled Transactions	9-5

APPENDIX A - MECHANICAL LOCK A-1
About the Dial A-2
To Lock A-2
Changing the Combination A-2

APPENDIX B - ELECTRONIC LOCK B-1
Entering the Combination B-2
Changing the Combination B-2
Lockout Feature B-2
Bad Battery/Battery Replacement B-3

APPENDIX C - WARRANTY POLICY C-1

SECTION 1 - INTRODUCTION

What's in This Manual

This manual describes the operating features of the Model 97XX-series Cash Dispenser family.

The setup and operating procedures given in this manual are generally applicable to any Model 97XX-series Cash Dispenser. If your Cash Dispenser does not have the ability to perform some of the features described in this manual, it is because your processor does not support the feature or the dispenser was purchased without that particular option.

In this manual, the terms Cash Dispenser, Dispenser, or Terminal are used interchangeably.

Cash Dispenser Families

The 97XX Cash Dispenser family consists of a number of Cash Dispenser models. The primary difference between the various models is in the type of *dispensing mechanism* installed. The dispensing mechanism holds and dispenses currency.

The 97XX family includes the 9700, 9705, 9710 and 9750 Cash Dispenser series. Each series, such as 9700-Series or 9710-Series, uses a dispensing mechanism that is unique to that series.

Each model in a model series, such as 9700-Series, uses the same type of dispensing mechanism, but provides other features that distinguish it from the other models in the series. The two primary characteristics that differentiate the various models in a series are: 1.) *Class of Service* and 2.) *Security Vault Access Type*

Class of Service (Business-vs-Level 1)

The basic Model 97XX is U.L. certified for Business Hours Service. This means that the currency should be removed from the dispenser and stored in a safe location when the business is closed to the public. Other dispensers in the 97XX family may be U.L. certified as "Level 1," providing additional security and the ability to store currency during non-business hours.

Security Vault Access (Front-vs-Rear)

The basic-model Cash Dispenser is a front-access machine, allowing access to the dispensing mechanism and currency cassettes from the front (control-panel side) of the unit. The rear-access models allow equivalent access from the rear of the unit.

WHAT IS A CASH DISPENSER?

A Cash Dispenser offers your customers the standard services commonly available from an Automatic Teller Machine (ATM), such as cash withdrawals, transfer of funds between accounts, and balance inquiries.

Once a withdrawal has been completed, the transaction processor (the organization that handles the connection between the terminal and the banking system "network") automatically debits the customer's account. The processor credits the merchant's account for the amount of the withdrawal plus any surcharge (if applicable) at the end of the business day.

As is typically the case with non-bank ("retail"-style) ATMs, the Cash Dispenser does not accept cash deposits.

Feature Highlights

Important features of the Model 97XX Cash Dispenser family are highlighted in the following list:

- Supports dial-up, LAN-based, or wireless (CDPD, VSAT and Radio-Pad) communications.
- Satisfies Americans with Disabilities Act (ADA) specifications for height and access.
- Audio output provides user-action feedback, as well as headphone accessible audible prompting for sight-impaired customers.
- Multi-function, dip-style Card Reader supports magnetic stripe cards or "smart" cards.
- Intuitive, user-friendly keypad and display interface.
- Fixed-head thermal printer designed for quiet operation.
- Integrated, lighted advertising panels. Supports an optional, integrated full-motion video display.
- 320-by-240, 256-color LCD display supports attention-getting graphics and user-selectable background screens. Monochrome display available as an option.
- Supports remote setup, configuration and monitoring via Triton Connect™.
- Supports single-cassette or multi-cassette configurations, depending upon installed dispensing mechanism.
- Dispenses U.S. and international currency types, as well as other paper-based media such as coupons or tickets.
- High-capacity electronic journal can store transactions for later printout and analysis.
- Modular architecture eases troubleshooting and servicing.
- Small footprint design makes placement easier.
- Cabinets available in *UL 291 Business Hours Service* or *UL 291 Level 1 Safe* models.



97XX without topper.



97XX cabinet with optional backlit advertising topper (or full-motion video display panel).

Standard Features

Standard features of the 97XX Cash Dispenser are summarized in the following paragraphs.

256-Color Display

The terminal LCD screen can display text and graphics in 256 colors, providing a richer visual experience to the user. Optional monochrome displays supported.

Selectable Background Screen-Graphic

This feature places a user-defined graphical screen or image on the screen background. Fixed screen elements such as menu buttons and labels will “float” above the background graphic. You can use this feature to enhance the appearance of the display, support advertising campaigns, branding opportunities, or other purposes.

Voice-Enabled Transactions

The terminal provides voice feedback via an integrated headphone jack, enabling sight-impaired users to plug in a set of headphones and receive spoken assistance as they perform a transaction. See Section 9, Customer Transactions, for more information on this feature.

MAC Data Encryption Support

The ATM implements support for the Message Authentication Code (MAC) data encryption protocol. This capability is typically referred to as “MAC-ing”. NOTE: This feature is currently only available in the Triton Standard versions of ATM Software.

MACing provides increased protection for message traffic to and from the ATM.

SPED PIN Entry Device Support

Secure PIN Entry Device (SPED) is an encryption system that offers additional protection for the customer PIN during entry at the ATM keypad.



Headphones are used for voice-enabled transactions.

DATAPAK 3000 Communications Protocol Support

The DATAPAK 3000 protocol enables the ATM to interface with designated DATAPAK intermediaries (in the Canadian market region), who in turn provide connectivity to the appropriate transaction processor. NOTE: This feature is only available for use in the Canadian market.

DATAPAK 3000 connectivity is typically faster and more cost-effective than a direct dial-up connection between the ATM and the transaction processor.

Close Scheduling

This function enables the operator of the terminal to establish a time at which the terminal will automatically initiate a close operation with the processor. If only manual initiation of a close is desired, this feature can be turned off.

Exit Message

This feature allows a message to be displayed to the customer at the conclusion of a transaction. The content of the message is determined by the operator.

Predial Capability

By initiating the call to the processor immediately after the PIN is keyed in, the actual transaction, once selected, can be completed more quickly. If desired, the predial capability can be disabled, in which case the call to the processor will not be made until after the customer actually chooses a transaction.

Alarm Thresholds

NOTE: This feature must be used in conjunction with Triton Connect version 3.0 or later.

This feature enables the terminal to detect and automatically report the following conditions to a remote personal computer (PC) that is running Triton Connect (version 3.0 or later):

- 1.) The level of cash in the cassette has fallen below a pre-defined threshold.
- 2.) The number of journal entries has risen above a pre-defined threshold.

- 3.) Scheduled transfer of electronic journal data to a remote Triton Connect host computer. This time can be set at the terminal or via Triton Connect

Transaction and Account Type Configuration

This feature enables the terminal operator to select the types of transactions (transfers or balance inquiries) or accounts (savings or credit card) that will be presented to the customer. This feature does not affect the availability of checking account withdrawal transactions, which are always presented.

Electronic Journal

The Cash Dispenser features a solid state electronic journal. The electronic journal is based on proven Triton technology and provides improved reliability and ease of use.

The details of each transaction are stored in the journal's memory, and can be retrieved at a later date. When needed, just the information desired can be recalled and a printout of the records made.

Normally, journal data is printed by the unit's receipt printer, but with the optional Triton Connect software package the information can be sent to a remote PC (Personal Computer) for storage and subsequent analysis.

The information in the electronic journal is maintained in a safe and secure environment. The journal is physically located in the lower security cabinet of the unit, making it as secure as the cash itself. Even after a transaction record has been printed to the receipt printer, it can still be read and printed again. Old records are retained in the electronic journal until 2045 records have been stored, at which time the journal must be printed or cleared.

The software on the terminal makes it easy to retrieve stored information as often as necessary. From the operator's standpoint, use of the journal is simple. All that is required of the operator is to do a PRINT JOURNAL command on a regular basis.

Typically, the journal should be printed out whenever a DAY CLOSE is completed, although this is not a requirement.

When the PRINT JOURNAL command is selected, only the records acquired since the last PRINT JOURNAL command will be printed. Therefore, you don't have to keep track of what record was printed last, because the terminal does it for you.

If the printed copy of a group of records is accidentally lost or destroyed, or the receipt printer runs out of paper before completely printing a group of records, it is a simple matter to reprint them, since they remain stored in the journal (until overwritten, as explained earlier).

Distributor EPROM Access With Challenge

This feature provides increased security by allowing each distributor to select their own unique EPROM access code for each terminal they sell or service. Procedures for entering and changing the EPROM Access Code are contained in the Cash Dispenser Installation and Service Manual.

Status Monitoring

This feature (not available with all versions of the terminal's operating software) allows information about the operational status of the terminal to be provided to the processor. The feature is activated using the terminal's Management Functions.

Language Option

The Cash Dispenser has a screen language option. This option allows the terminal user to select a preferred language (such as Spanish) when beginning an ATM transaction.

International Monetary Support

This feature allows installation and service personnel to select one of a number of monetary symbols (such as C, ¢, \$, f, L, Pt., £, Q, ¥) that describe the type of currency that will be dispensed by the Cash Dispenser. The default symbol can be viewed and changed through the Management Functions.

Six-Digit Amount Entry Fields

U.S. domestic versions of the terminal operating software allow up to six digits to be entered in all fields where a cash amount is expected. Some international versions of the software allow extended field-lengths (see Extended Fields).

Receipt Printer Paper Low Option

This feature allows the end user to determine whether or not the terminal is allowed to continue processing transactions when the receipt printer paper is low.

Graphics Memory

The terminal is equipped with dedicated Graphics Memory, which enables graphical Ad screens to be downloaded and displayed on the Cash Dispenser's LCD screen.

AD Screens

An Ad Screen is a promotional or advertising graphic that is displayed on the Cash Dispenser LCD screen. It is displayed alternately with the Customer Welcome screen graphic (while the terminal is idle) and while a customer transaction is being processed. Triton Connect Software Release 1.8 or higher is required to support the use of AD Screens.

Text-Based AD Screens

Text-based AD Screens can be displayed to the customer while the terminal is performing a transaction. A maximum of four text-based ads can be displayed during the interval that the "Transaction Processing - Please Wait" message screen is being shown to the customer. Each ad consists of up to eight lines of text, and each ad can be displayed for an operator-specified duration.

The messages are created and downloaded to the terminal using Triton Connect Software Release release 1.8 or above.

Receipt Printer Graphics

Triton Connect Software Release 1.8 or higher allows a bit-mapped graphic image in ".bmp" format to be downloaded to the terminal. This graphic is printed on the receipt when the PRINTED GRAPHIC option is enabled through the Management Functions. This feature utilizes the Cash Dispenser's Graphics Memory.

Prize Coupons Option

The Cash Dispenser may be configured to award "prize coupons" to customers on a random chance or a withdrawal amount-determined basis. Coupons are awarded as printed messages presented to the customer on a separate receipt. The messages consist of four lines of text, with up to 40 characters in each line. The text of the message is entered from the terminal's keypad.

There are two methods of awarding coupons. The RANDOM approach awards coupons randomly within a specified percentage range (such as 3% of transactions) set in the management Functions.

The LEVEL approach awards a coupon to each customer that withdraws an amount equal to or greater than a specific dollar value that is set in the Management Functions.

When a coupon is awarded, the cash dispenser beeps a distinctive tone, displays a message to alert the customer and prints a coupon after the money is dispensed (but before the customer receipt is printed). The prize coupon is printed on a separate receipt and a full cut is made between the coupon and the customer receipt.

Receipt Option

This feature gives customers the option of receiving or not receiving a receipt after completing a withdrawal transaction. The factory default for the RECEIPT OPTION is disabled, meaning a receipt will always be issued after each withdrawal transaction.

If the RECEIPT OPTION is enabled, the customer is given the option of choosing to receive or not receive a printed receipt at the end of the withdrawal transaction. If the customer fails to make a choice, the receipt will be printed automatically after a 40-second delay.

Triton Connect

Triton Connect is an optional software package available through your service provider that facilitates remote data retrieval and monitoring of your Triton Systems Cash Dispenser. The advantages of this feature are reduced service calls and simplified terminal configuration changes, which in turn provides more immediate and economical service for you.

The Triton Connect software runs on a remote host computer, and uses standard dial-up telephone lines to access and monitor the terminal. Triton Connect operates by dialing up the terminal and retrieving its data.

The Triton Connect host computer can monitor your Cash Dispenser 24 hours a day, seven days a week, and can receive an incoming call from the Cash Dispenser if there is a system error or service is required.

The Terminal Configuration options in the Management Functions area enable you to activate or deactivate Triton Connect access to the terminal.

Key information about the status of the terminal is collected and stored at a central location by your service provider.

WHAT IS TRITON CONNECT?

Triton Connect is PC (Personal Computer) based software that enables you to remotely your terminals.

Triton Connect increases efficiency and reduces costs associated with managing terminals. Significant advantages include:

Operation on a single, stand-alone PC or in a networked environment

Can perform a wide range of monitoring and control functions from a central location.

Supports CDPD (cellular-wireless), dial-up and satellite communications with remote terminals.

With this data, customer transaction reports can be developed that make it easy to monitor your Cash Dispenser's performance, schedule cash replenishment, and provide instant status for service dispatch should a problem occur.

Extended Amounts

The standard length of a currency amount entry field is 6 characters in U. S. domestic versions of the terminal operating software. In some international applications this length is insufficient to allow the entry of the full range of monetary values available in the local currency type. The Extended Amounts feature allows the selection of 12-character currency amount entry fields for those applications that require it.

Once selected, the Cash Dispenser can accept the entry of extended amounts for customer withdrawal and transfer transactions. The feature is activated using the terminal's Management Functions.

Date/Time Format

This option allows the operator to select either MM/DD/YY or DD/MM/YY as the format the terminal will use when printing receipts and other reports.

Dispense Counter

This feature counts the number of bills that have been dispensed from the currency cassette and prints the total on the Receipt Printer Test report

SECTION 2 - BASIC OPERATION

Introduction

This chapter describes the basic operation of the terminal. The following topics are covered:

- 1.) **Menu-Based Operation.** This section gives a general overview of the terminal display interface.
- 2.) **Keypad Operation.** Describes the layout and use of the display and alphanumeric keypads.
- 3.) **Changing to Management Functions.** Describes how to access the terminal's Management Functions.

Menu-based Operation

The terminal operates as a menu driven system. Messages and menu options presented on the LCD display screen guide the user's actions. The desired menu option is selected by pressing one of the screen keys located to the left and right of the display. For the purpose of security many screens timeout after a preset time interval, usually 30 seconds. The timeout length may vary depending on the function being performed.

When a screen timeout occurs, a screen is presented which asks the user if more time is needed. If the user chooses NO, the Customer Welcome screen will be presented. If YES is chosen, the user is returned to the function that was active prior to the timeout. If the user does not make a selection within an additional 30-second countdown period the terminal will automatically go to the Customer Welcome screen.

When the unit is turned on, the dispenser will beep once and the Top Menu, shown in Figure 2-1, will appear on the display screen after a few seconds. From the Top Menu, you can either:

- 1.) Activate the terminal to perform customer transactions by pressing the key next to CUSTOMER TRANSACTIONS.
- 2.) Enter the terminal system management area by pressing the key next to MANAGEMENT FUNCTIONS.

If you do not select a menu choice within 30 seconds the terminal will automatically default to the Customer Welcome screen (a benefit of this feature is that in the event of a power interruption the terminal will automatically begin accepting customer transactions shortly after power is restored).



Figure 2-1, Top menu.

Keypad Operation

See Figure 2-2. The user interface of the terminal consists of the LCD display and 24 rubber keys on three keypads. The primary menu navigation keys are arranged in two four-key groups, one group on either side of the LCD display. The main keypad consists of 10 alphanumeric keys, two arrow keys and four large control keys, all located in a 16-key group beneath the LCD display.

All of the keys that a customer would use to conduct transactions have an integral raised Braille symbol to conform to the requirements of the Americans with Disabilities Act. To activate a key, press it until a beep is heard. If the key does not beep, it means that the key is not active for the current function, or the key was not pressed firmly enough.

The entry of numeric characters via the keypad is straightforward: simply press the desired key. However, in certain management function screens it may be necessary to enter alphabetic characters, a procedure that requires a little more explanation. On such screens a flashing cursor will be evident on the display, representing the location where the next character you enter will be displayed. To enter a letter or punctuation mark, you will first press the <CTRL> key (the blank key in the lower right-hand corner of the keypad), and then you will press the number that has the letter or other character you want.

Each of the numbered keys (<0> through <9>) has six characters available. See Figure 2-3, Alphanumeric Keypad, and Table 2-1, Keypad Characters. On most of these keys (<2> through <9>), the first three of the available characters are alphabetic, and are printed on the keycap above the number character. Two keys, the <0> and <1>, are different. The <0> key does not show any additional characters, while the <1> key shows two alphabetic characters ('QZ').

The first character on the first key (0-9) you press after the <CTRL> key will be displayed at the current cursor position. Pressing the same key repeatedly will cycle the displayed letter through the available character choices for that key (X1-X6). When the desired character is displayed, press the <RIGHT ARROW> key to 'lock it in' and move the cursor to the next position. Repeat these steps to enter the next character.

The <RIGHT ARROW> and <LEFT ARROW> keys are used in most alphanumeric data entry situations. The <LEFT ARROW> is used to back up and erase a character. The <RIGHT ARROW> is used to lock in a character. These keys will auto-repeat if held down for more than one second.



Figure 2-2, Control Panel Interface.

The <CLEAR> key can be used to clear an entry and start over. The <CANCEL> key will abort the current transaction.

The keys located beside the display are called the Screen Keys. They are used in the selection of menu functions. A Screen Key is only active when a function or menu option name is displayed beside the key.

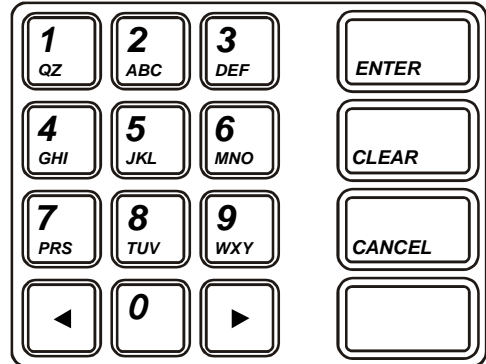

Figure 2-3, Alphanumeric keypad.

KEYPAD CHARACTERS						
	X1	X2	X3	X4	X5	X6
1	Q	Z	Space	~	!	@
2	A	B	C	#	\$	%
3	D	E	F	^	^	-
4	G	H	I	()	
5	J	K	L	\	/	"
6	M	N	O	;	:	' Single Quote (Open)
7	P	R	S	?	<	>
8	T	U	V	[]	ñ
9	W	X	Y	{	}	' Single Quote (Close)
0	,	.	-	&	=	+

Table 2-1, Keypad Characters.

Accessing Management Functions

You can enter the terminal MANAGEMENT FUNCTIONS main menu screen by performing any one of the three procedures listed below:

1. If the Customer Welcome screen is being displayed, press and hold down the <CTRL> key; while holding down the <CTRL> key, press the <1> key. Release both keys. After a moment the Top Menu screen (shown in Figure 2-1) will be displayed. Select the MANAGEMENT FUNCTIONS option.
2. Reset the terminal by removing and reapplying power to the terminal. When the Top Menu is displayed select MANAGEMENT FUNCTIONS.
3. Remove and then reapply power to the terminal using the ON/OFF switch located on the right side of the card cage inside the upper enclosure of the terminal. When the Top Menu is displayed select MANAGEMENT FUNCTIONS.

The Top Menu allows you to choose one of two options, CUSTOMER TRANSACTIONS or MANAGEMENT FUNCTIONS. Selecting CUSTOMER TRANSACTIONS changes the display to the Customer Welcome screen so the terminal is ready to perform customer transactions. Selecting MANAGEMENT FUNCTIONS opens the password screen, which in turn provides access to menus that are used for changing or viewing terminal parameters.

Whenever the MANAGEMENT FUNCTIONS choice is selected, the terminal will ask for a password to be entered. For a first-time configuration, enter the default MASTER PASSWORD of '123456' on the keypad and then press the <ENTER> key. This 'default' password will be valid until it is changed.

****NOTE****

The operator of the terminal must change the MASTER PASSWORD to a new password when the installation is complete.

The Top Menu serves an alternative purpose in the event of a machine malfunction or other error condition. Such conditions are normally reported by an "OUT OF SERVICE" message screen. The typical response to this message is to reset the terminal. After resetting the terminal the Top Menu screen will display any applicable status messages and error code numbers.

The two options presented in such instances will be RESET ERROR and MANAGEMENT FUNCTIONS. Press RESET ERROR to attempt to clear the error, or enter the MANAGEMENT FUNCTIONS area, as desired. See Section 8, Error Recovery, for more information.

SECTION 3 - INITIAL SETUP

Cash Dispenser Parameter Categories

There are a number of setup parameters that must be configured when a Cash Dispenser is installed. Generally speaking, these parameters can be grouped into the following major categories:

- Communications
- Security
- Surcharging
- Currency Settings
- Cassette Setup
- Transactions
- Receipts
- Coupons
- Languages
- Messages
- Ad Screens
- Date/Time Settings
- Status Monitoring
- Close
- User Interface
- Options

Each area consists of one or more individual parameters. In terms of Cash Dispenser operation, the importance level of individual parameters within a category can be described as *Critical*, *Required*, *Important*, or *User-Defined*.

Parameter Importance Levels

Critical

The parameters with this importance level are primarily those that represent the minimum number of parameters that must be correctly configured in order to process transactions. In addition, because of the importance of protecting access to the Cash Dispenser Management Functions, the access password parameters are also included in this category. The primary parameters in this category include various Communications and Security (including access password) parameters.

Required

These parameters further satisfy your transaction processor's setup or operational requirements. Parameters in this area define the ability of your Cash Dispenser to offer various types of transactions, to correctly present those transactions to the customer and to accurately record those transactions. Surcharging, Currency, Cassette and Transactions parameters fall into this category.

Important

These parameters are used to manage transaction activity record-keeping, enable remote monitoring of Cash Dispenser operation, and to ensure receipts and other records are accurately annotated with the correct date and time. Status Monitoring, Close and Date/Time parameters are included in this category.

User-Defined

These parameters are configured at your discretion, and are used to customize the appearance and functionality of the Cash Dispenser to meet the unique language needs of your intended customers, adjust user interface appearance, satisfy advertising or promotional requirements, or meet other locale-specific requirements. The management of optional features is also included in this area. Languages, Receipts, Coupons, Messages, Ad Screens, User Interface and Options parameters fall into this category.

NOTE: The importance-level of individual parameters as described in this manual is provided as a general guide, to assist you in understanding and prioritizing the setup requirements of your Cash Dispenser. If, after evaluating your unique requirements, you feel that a parameter is more (or less) important to your particular needs, you are free to treat that parameter accordingly.

Cash Dispenser Setup Parameters

Tables 3-1 through 3-4 list Critical, Required, Important and User Defined parameters, respectively. Each table lists the applicable Cash Dispenser model series (9700+, for example, represents the 9700-Series product line), Parameter Category, Name and Page Number (in Section 5, Management Functions) of each parameter listed. In most cases the factory default value for each parameter is also provided.

IN TABLE 3-1, CRITICAL SETUP PARAMETERS, THE NAMES OF THOSE PARAMETERS THAT ARE TYPICALLY THE MINIMUM NUMBER REQUIRED IN ORDER TO PERFORM A TRANSACTION HAVE BEEN HIGHLIGHTED. CHECK WITH YOUR TRANSACTION PROCESSOR FOR YOUR SPECIFIC REQUIREMENTS!

IMPORTANT: Although many of the Cash Dispenser's parameters have been set at the factory, it is important to verify that the settings are appropriate for your needs. Change the factory default values as necessary to reflect the actual settings you require.

TABLE 3-1 - CRITICAL SETUP PARAMETERS

	9700+	9705+	9710+	9750+	CATEGORY	PARAMETER	FACTORY DEFAULT	PAGE NO.
1	X	X	X	X	SECURITY	MASTER PASSWORD	123456	5-41
2	X	X	X	X	SECURITY	ADMINISTRATION PASSWORD	987654	5-42
3	X	X	X	X	COMMUNICATIONS	SET TERMINAL #	NONE	5-71
4	X	X	X		CASSETTE	MULTIPLE AMOUNT	\$0.00	5-85
5	X	X	X	X	COMMUNICATIONS	PRIMARY NUMBER (TELEPHONE)	NONE	5-112
6	X	X	X	X	COMMUNICATIONS	BACKUP NUMBER (TELEPHONE)	NONE	5-113
7	X	X	X	X	COMMUNICATIONS	DATAPAK ACCESS CODE	*	5-114
8	X	X	X	X	COMMUNICATIONS	COMPUSERVE ID	*	5-116
9	X	X	X	X	COMMUNICATIONS	DIAL MODE	DTMF	5-118
10	X	X	X	X	COMMUNICATIONS	DIAL RATE	FAST	5-119
11	X	X	X	X	COMMUNICATIONS	BAUD RATE	1200	5-120
12	X	X	X	X	COMMUNICATIONS	MODEM SETUP STRING	*	5-121
13	X	X	X	X	SECURITY	ENTER MAC MASTER KEY	*	5-101
14	X	X	X	X	SECURITY	ENTER PIN MASTER KEY	*	5-103
15	X	X	X	X	SECURITY	INJECT MASTER KEYS	*	5-105
16	X	X	X	X	SECURITY	ENTER MAC WORKING KEY	*	5-106
17	X	X	X	X	SECURITY	ENTER PIN WORKING KEY	*	5-108
18	X	X	X	X	SECURITY	DOWNLOAD WORKING KEYS	*	5-110

*SEE SECTION 5, MANAGEMENT FUNCTIONS, FOR MORE INFORMATION.

TABLE 3-2 - REQUIRED SETUP PARAMETERS

	9700+	9705+	9710+	9750+	CATEGORY	PARAMETER	FACTORY DEFAULT	PAGE NO.
1	X	X	X	X	SURCHARGING	SURCHARGE MESSAGES	*	5-63
2	X	X	X	X	SURCHARGING	SURCHARGE OWNER	*	5-66
3	X	X	X	X	SURCHARGING	SURCHARGE PERCENT	0%	5-74
4	X	X	X	X	SURCHARGING	LESSER/GREATER SELECTION	LESSER	5-74
5	X	X	X	X	SURCHARGING	ENABLE/DISABLE SURCHARGE	DISABLED	5-75
6	X	X	X	X	SURCHARGING	SURCHARGE LOCATION	BEGINNING	5-76
7	X	X	X	X	SURCHARGING	BLOCK ISO'S	NONE	5-77
8	X	X	X	X	SURCHARGING	SURCHARGE AMOUNT	\$0.00	5-79
9	X	X	X	X	CURRENCY	ENTER QTY. IN CASSETTE	0	5-14
10				X	CASSETTE	RELEARN BILL THICKNESS	*	5-81
11	X	X	X		CASSETTE	LOW CURRENCY	ENABLED	5-82
12	X	X	X	X	CASSETTE	INTERNATIONAL CURRENCY	*	5-83
13	X	X	X	X	CASSETTE	MAXIMUM AMOUNT	\$500.00	5-84
15				X	CASSETTE	MAX. NON-CASH	\$0.00	5-86
16	X	X	X	X	CASSETTE	EXTENDED AMOUNT	DISABLED	5-87
17				X	CASSETTE	SET BILL DIMENSION	*	5-89
18				X	CASSETTE	VALUE	*	5-90
19				X	CASSETTE	TYPE	CASH	5-91
20				X	CASSETTE	SERVICE	IN SERVICE	5-92
21				X	CASSETTE	CURRENCY DATA	*	5-93
22				X	CASSETTE	DESCRIPTION	NONE	5-96
23	X	X	X	X	CASSETTE	FAST CASH AMOUNT	*	5-99
24	X	X	X	X	TRANSACTIONS	TRANSACTION TYPES	ON	5-156
25	X	X	X	X	TRANSACTIONS	ACCOUNT TYPES	ON	5-157

*SEE SECTION 5, MANAGEMENT FUNCTIONS, FOR MORE INFORMATION.

TABLE 3-3 - IMPORTANT SETUP PARAMETERS

	9700+	9705+	9710+	9750+	CATEGORY	PARAMETER	FACTORY DEFAULT	PAGE NO.
1	X	X	X	X	CLOSE	SCHEDULE CLOSE	OFF	5-6
2	X	X	X	X	CLOSE	CHANGE SCHEDULE	*	5-7
3	X	X	X	X	CLOSE	SEND TERMINAL TOTALS	OFF	5-8
4	X	X	X	X	COMMUNICATIONS	PREDIAL ON/OFF	OFF	5-115
5	X	X	X	X	STATUS MONITORING	PRIMARY NUMBER (TRITON CONNECT)	NONE	5-127
6	X	X	X	X	STATUS MONITORING	BACKUP NUMBER (TRITON CONNECT)	NONE	5-128
7	X	X	X	X	STATUS MONITORING	PRIMARY ALARM NUMBER (TRITON CONNECT)	NONE	5-130
8	X	X	X	X	STATUS MONITORING	BACKUPALARM NUMBER (TRITON CONNECT)	NONE	5-131
9	X	X	X	X	STATUS MONITORING	ENABLE/DISABLE CALLBACK	ENABLED	5-132
10	X	X	X	X	STATUS MONITORING	ENABLE/DISABLE TRITON CONNECT	DISABLED	5-133
11	X	X	X	X	STATUS MONITORING	STATUS MONITORING	DISABLED	5-135
12	X	X	X	X	STATUS MONITORING	HEARTBEAT MESSAGE	*	5-136
13	X	X	X	X	STATUS MONITORING	ENABLE/DISABLE COMMUNICATION HEADER	DISABLED	5-140
14	X	X	X	X	STATUS MONITORING	CHANGE COMMUNICATION HEADER	*	5-140
15	X	X	X	X	STATUS MONITORING	ALARM THRESHOLDS	OFF	5-142
16	X	X	X	X	STATUS MONITORING	SET LOW CASH THRESHOLD	0	5-143
17	X	X	X	X	STATUS MONITORING	SET JOURNAL THRESHOLD	0	5-144
18	X	X	X	X	STATUS MONITORING	SET SCHEDULED JOURNAL	0	5-145
19	X	X	X	X	DATE/TIME	SET DATE FORMAT	MM/DD/YY	5-152
20	X	X	X	X	DATE/TIME	SET DATE	N/A	5-154
21	X	X	X	X	DATE/TIME	SET TIME	N/A	5-155

*SEE SECTION 5, MANAGEMENT FUNCTIONS, FOR MORE INFORMATION.

TABLE 3-4 - USER-DEFINED SETUP PARAMETERS

	9700+	9705+	9710+	9750+	CATEGORY	PARAMETER	FACTORY DEFAULT	PAGE NO.
1	X	X	X	X	LANGUAGES	ENGLISH/INGLES	*	5-32
2	X	X	X	X	LANGUAGES	SPANISH/ESPAÑOL	*	5-33
3	X	X	X	X	LANGUAGES	ENABLE/DISABLE CUST. OPTION	DISABLED	5-34
4	X	X	X	X	RECEIPTS	SET PRINT LENGTH	35	5-45
5	X	X	X	X	RECEIPTS	LOW RECEIPT PAPER	OFF	5-46
6	X	X	X	X	RECEIPTS	PRINTER GRAPHICS	DISABLED	5-47
7	X	X	X	X	RECEIPTS	RECEIPT OPTION	DISABLED	5-125
8	X	X	X	X	COUPONS	ENTER LEVEL PRIZE MESSAGE	NONE	5-50
9	X	X	X	X	COUPONS	ENTER RANDOM PRIZE MESSAGE.	NONE	5-51
10	X	X	X	X	COUPONS	ENABLE/DISABLE COUPON AWARD	DISABLED	5-52
11	X	X	X	X	COUPONS	SET LEVEL PRIZE AMOUNT	\$0.00	5-53
12	X	X	X	X	COUPONS	SET RANDOM WINNING %	0%	5-54
13				X	COUPONS	SELECT LEVEL COUPON CASS.	NONE	5-56
14				X	COUPONS	SELECT RANDOM COUPON CASS.	NONE	5-57
15				X	COUPONS	ENABLE/DISABLE COUPON AWARD	DISABLED	5-58
16				X	COUPONS	SET LEVEL PRIZE AMOUNT	\$0.00	5-59
17				X	COUPONS	SET RANDOM WINNING %	0%	5-60
18	X	X	X	X	MESSAGES	MARKETING MESSAGE	*	5-62
19	X	X	X	X	MESSAGES	WELCOME MESSAGE	*	5-65
20	X	X	X	X	MESSAGES	EXIT MESSAGE	*	5-67
21	X	X	X	X	MESSAGES	STORE MESSAGE	*	5-68
22	X	X	X	X	MESSAGES	TERMINAL OWNER	*	5-69
23	X	X	X	X	USER INTERFACE	ADJUST VOLUME/CONTRAST	*	5-124
24	X	X	X	X	AD SCREENS	ENABLE/DISABLE AD SCREENS	DISABLED	5-139
25	X	X	X	X	USER INTERFACE	BACKGROUND GRAPHIC	OFF	5-146
26	X	X	X	X	OPTIONS	VIEW/MODIFY OPTIONS	*	5-147

*SEE SECTION 5, MANAGEMENT FUNCTIONS, FOR MORE INFORMATION.

SECTION 4 - CURRENCY HANDLING

Introduction

The purpose of this section of the manual is to describe the procedures for: (1) Removing and replacing note cassettes, (2) Loading cassettes, and (3) Removing and replacing the Reject Notes (as applicable). Information concerning note handling and quality issues are explained where appropriate.

Dispensing Mechanisms

The 97XX series Cash Dispensers use a variety of dispensing mechanisms. Depending upon Cash Dispenser model, the dispensing mechanism may hold one or more Note Cassettes. The Reject collection method may use a reject compartment that is integrated into the Note Cassette, or a separate reject container. Currency capacity depends upon the dispenser mechanism installed in the Cash Dispenser, but is also affected by note quality and thickness. Typical capacities are provided in the following table:

97XX MODEL FAMILIES		
MODEL FAMILY	CASSETTE	APPROXIMATE CURRENCY CAPACITY
9700-Series	Single Cassette	2100 Notes
9705-Series	Single Cassette	550-1000 Notes
9710-Series	Single Cassette	750-1000 Notes
9750-Series	Single/Multiple Cassette	3000 Notes per cassette

The dispensing mechanism delivers the appropriate number of notes from the Note Cassette(s) to fulfill the customer's withdrawal request. The purpose of the Reject area or vault is to accept and hold notes that have been transferred from the Note Cassette(s) but not dispensed. Some situations that could cause the mechanism to reject notes are: (1) Multiple notes stuck together and (2) Note width too short or long. Other conditions that could cause a reject are described in the next section, Media Condition.

LEARNING NOTES

IMPORTANT! The first time a 9705 or 9750-series dispenser is used, the mechanism will enter a learning mode, during which it will reject some notes as it learns the average thickness of the currency. In such cases, it is recommended that you remove the rejected notes from the unit before placing the Cash Dispenser into service.

WARNING

DO NOT RECYCLE REJECTED NOTES INTO A CASSETTE! Doing so could cause more rejects and/or currency jams.

Media Condition

If possible, store currency at room temperature for at least eight hours before dispensing from the cassettes.

The number of rejects can be directly influenced by the technique used to load the cassettes and the quality of the currency. Notes loaded into the cassettes must be in "fit" condition if a high level of performance (low reject and failure rate) is expected from the unit. "Fit" notes do not possess any of the defects listed here:

Used Note Defects

- Adhesive or "sticky" substances on the surface of the paper.
- Tears extending more than 1/2" from the edge of the currency.
- Tears, holes, or missing sections in the body of the currency.

- Tape on the surface of the currency used for repairing, patching or any other purpose.
- Staples, pins, or any other foreign body attached to the notes.
- Corner folds of a size greater than 1/2" on either axis.
- Two or more notes joined by any means.
- Excessively crumpled or crinkled.

New or Uncirculated Note Defects

- All the conditions listed for used notes.
- Excessive bowing due to conditions of packing and storing.
- New or uncirculated currency must be "burst" and fully separated prior to loading into cassettes.

Preparing Notes

Use the following procedures to prepare notes before inserting them into a Note Cassette.

Preparing Used Notes

- Remove the band around each bundle of notes.
- Remove foreign objects (e.g. pins, paper clips, crumbs, etc.).
- Remove torn or very worn notes.
- Straighten any folded notes.

Preparing New or Uncirculated Notes

- Remove the band around each bundle of notes. Separate the notes from each other by:
 - Striking the bundle hard against the edge of a table or similar object.
 - Flipping through each bundle of notes in both directions at each end.
- Using a Note Counter.

MODEL 9700-SERIES

Replenishing Cassettes

1. Open the Cash Dispenser security container via the enclosure lock on the front of the unit. The combination lock must then be opened to gain access to the security container.
2. To remove the cassette, grasp the handle on the front of the Cash Dispenser mechanism with one hand while holding the mechanism in place with the other hand and pull sharply. **Do not allow the cassette to swing freely when it is pulled out. It may strike a near by object or person causing damage to or injury to what it strikes!**



Removing cassette.

3. The cassette must be primed with the cassette key before it can be inserted onto the loading tray. Insert the key and turn clockwise to show the green indicator in the window on the side of the cassette.

*****CAUTION*****

If RED is indicated in the window on the side of the currency cassette, NEVER attempt to insert the cassette into the Cash Dispenser or the loading tray!

4. Place the cassette onto the loading tray with the back of the cassette facing the probes on the tray. The shutter is unlocked as the cassette is pushed into the probes.



Loading Tray.

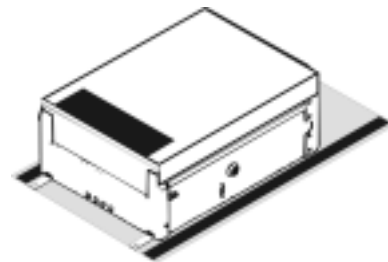

Cassette on Loading Tray.

5. Lift the cassette lid to expose the reject tray. Remove any rejected notes. Lift the reject tray to gain access to the currency compartment.

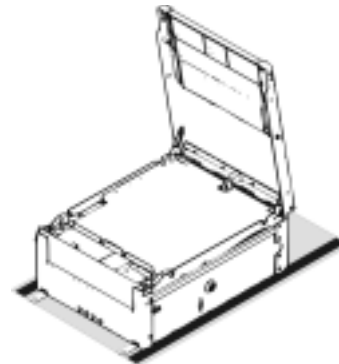

Cassette opened.

****WARNING****

DO NOT RECYCLE REJECTED NOTES INTO A CASSETTE! Doing so could cause more rejects and/or currency jams.

6. Pull the packer plate to the rear of the cassette (away from the shutter) until it locks to the white packer plate latch. It will be necessary to push down on the packer plate latch to lock the packer plate in place. The packer plate will be held in this position until the lid is closed or the latch is released by pushing it down. Be careful not to release the packer plate onto your fingers.
7. Place the currency into the cassette. Allow at least one inch of clearance between the packer plate when it is fully retracted and the currency. This will allow the packer plate to compress the currency.

- **Slanting pile**

To avoid dispensing problems caused by a "slanting" pile, put the notes in neat bundles of no more than $\frac{1}{2}$ to $\frac{3}{4}$ inches in thickness (100-200 notes). Turn every other bundle around to minimize slanting of the pile (bundle should have the same height on both sides, if possible).



Loading slanted notes.

- **Cupped bundle**

To avoid dispensing problems caused by cupped bundles, turn all the bundles with the cupped side towards the dispense opening of the note tray (opposite end from the handle).

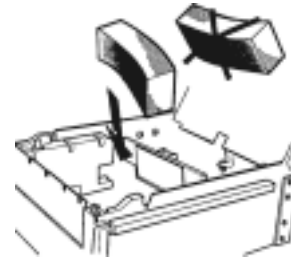

Loading cupped notes.

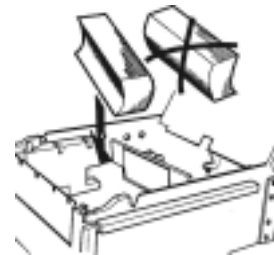

Loading cupped notes.

- **Mixed (Slanting and Cupped) bundles**

Separate the mixed currency into neat bundles of 100-200 notes of each type. Place the cupped bundles nearest the dispense opening of the tray, with the cupped side facing the opening. Turn every other slanted bundle around to give the bundles the same height on both sides and place after the cupped bundles.

- **Old and New Notes**

Always place the bundles containing old notes into the cassette first (nearest the handle) and bundles containing new notes last (nearest the dispense opening).



Place old notes together.

- **Common notes**

Simply place the prepared bundles in the tray.

8. Make sure the note pile is as even as possible. If necessary, use your hands to smooth and level the pile.



Level the note pile.

9. Release the packer plate and lower the reject tray and the lid. The cassette can now be removed from the loading tray by sliding it away from the probes.
10. **Verify that the cassette is primed.** Be certain the green indicator is showing in the window below the key! Install the cassette into the Cash Dispenser by placing the cassette guides on the dispensers' rails and firmly pushing the cassette in until it locks in place.



Installing cassette.

11. Close and lock the Cash Dispenser.

MODEL 9705-SERIES

Removing the Currency Cassette

1. **Ensure the terminal is not in use before removing the note cassette!** Removing the note cassette while the machine is in operation (processing customer transactions, performing close operations, etc.) can cause the terminal to enter an "Out of Service" condition!
2. Open the outer fascia panel to gain access to the security container door, using the key lock on the front of the panel. Open the combination lock on the security container door and open the door to gain access to the dispensing mechanism.
3. Some cabinets employ a slide-rail mounting system. On these cabinets, two levers are used to release the slide-tray lock, allowing the slide tray to be pulled out. Lift up on the locking levers that are on either side of the front edge of the dispenser slide tray and carefully slide the tray out to the access position.



Lift up on slide tray locking levers.

Other cabinets may use a fixed-tray mounting system. In these cases the dispensing mechanism mounting tray does not slide out of the cabinet. You will simply rotate the mechanism to the service position (as described in the next step) in order to access the currency and reject cassettes.

4. To gain access to the cassettes, rotate the mechanism mounting platform to the service position. To do this, locate the spring-loaded locking pin on the underside of the slide tray. This pin lets you lock the dispenser's swivel mounting platform into various quarter and half-turn access positions.



Slide dispenser out to access position.

Pull the pin down to release the swivel mounting platform. Slowly turn the tray so that the note and reject cassettes can be accessed from the side. Release the locking pin and move the mounting platform back and forth slightly to ensure the pin snaps back into place, locking the mounting platform into the service position.



Pull release pin for swivel platform.

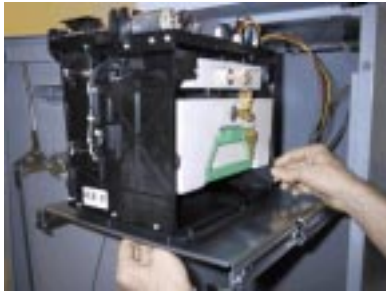

Turn mounting platform to access position.

5. To remove the note cassette, grasp the cassette handle and pull in a firm but controlled manner to release the cassette from the snap catches. Try to use only the minimum amount of force to release the cassette! The cassette will only move a few inches! Once released from the snaps you can slide the cassette out of the mechanism. Place the cassette on a level, flat surface for servicing.



Removing note cassette.



Note cassette removed from dispenser.

Loading the Currency Cassette

1. Unlock the cassette and open the cassette lid using the supplied key. Move the pusher plate to the rear of the cassette (toward the handle).

Note: The pusher plate action will depend on the type of cassette in use. Some cassettes require you to maintain pressure on the pusher plate as needed while loading notes. Other cassettes use a locking mechanism to hold the packer plate in the loading position. On these cassettes, pull the pusher-plate all the way back to the handle end of the cassette and turn the key to latch the pusher plate into the loading position.



Unlock note cassette.



Open the note cassette lid.



Pull the packer back. Some cassettes allow the pusher-plate to be latched in position using the key-lock.

2. **IMPORTANT:** The shape of some notes may be affected by conditions of storage or bundling, preventing them from forming neat, even piles. If not corrected, such conditions may cause notes to be rejected by the dispensing mechanism.

To compensate for the most common conditions of slanting or cupped note piles, follow the directions given next.

Notes with no apparent shape problems are referred to as "common" notes.

- **Slanting Pile**

To avoid dispensing problems caused by a "slanting" pile, put the notes in neat bundles of no more than $\frac{1}{2}$ to $\frac{3}{4}$ inches in thickness (100-200 notes). Turn every other bundle around to minimize slanting of the pile (bundle should have the same height on both sides, if possible).

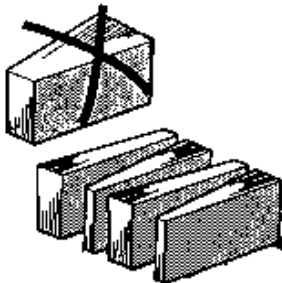

Alternate slanted bundles.

- **Cupped bundle**

To avoid dispensing problems caused by cupped bundles, turn all the bundles with the cupped side towards the dispense opening of the note cassette (opposite end from the handle).

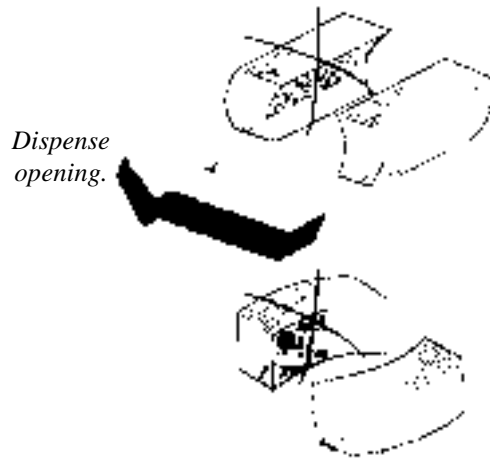

Turn cupped sides toward dispense opening.

- **Mixed (Slanting and Cupped) bundles**

Separate the mixed currency into neat bundles of 100-200 notes of each type. Place the cupped bundles nearest the dispense opening of the cassette, with the cupped side facing the opening. Turn every other slanted bundle around to give the bundles the same height on both sides and place after the cupped bundles.

- **Old and New Notes**

Always place the bundles containing old notes into the cassette first (nearest the handle) and bundles containing new notes last (nearest the dispense opening).

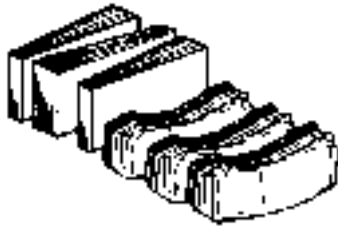

Place old notes together.

- **Common notes**

Simply place the prepared bundles in the cassette.

3. Make sure the note pile is as even as possible. If necessary, use your hands to smooth and level the pile.
4. On cassettes that do not use a pusher-plate locking mechanism, release the pusher plate against the notes. If the cassette uses pusher-plate locking, turn the key to release the catch, allowing the pusher plate to compress the notes.



Load notes.

5. Close and lock the cassette. Remove the key. Slide the cassette back into its compartment in the dispensing mechanism. Make sure the cassette is fully inserted! You will feel the cassette latch securely into the snap catches.

Removing the Reject Cassette

The reject tray is located just above the currency cassette in the dispensing mechanism. Follow these steps to remove the reject tray:

1. Slide the reject tray out of its compartment in the dispensing mechanism. Place the tray on a flat surface.



Remove reject cassette.

2. Unlock the tray using the supplied key. Flip the top back to gain access to the reject compartment.



Unlock and open reject cassette.

3. Remove any notes in the reject compartment.

****WARNING****

DO NOT RECYCLE REJECTED NOTES INTO A CASSETTE! Doing so could cause more rejects and/or currency jams.

4. Close and lock the reject tray. Remove the key. Slide the cassette back into its compartment in the dispensing mechanism. Make sure the reject cassette is fully inserted! You will feel the cassette snap securely into the catches.

You may wish to record the denomination and number of notes removed from the reject tray, for use when balancing the note tray against the cassette/day close records.

Reinstalling the Dispenser Mechanism

1. After reinstalling the currency and reject cassettes, pull down on the swivel platform locking pin to allow the swivel platform to turn.

Rotate the mechanism back to the operating position.

Slide rail locking tab.



Mechanism in operating position. If unit is slide-mounted, release locking tab and slide dispenser into cabinet.

If the mechanism uses a slide-rail mounting system, press in on the slide rail locking tab as you slide the mechanism back into the cabinet.

2. Close and lock the security cabinet.

MODEL 9710-SERIES**Removing the Note Tray**

1. **Ensure the terminal is not in use before removing the note tray!** Removing the note tray while the machine is in operation (processing customer transactions, performing close operations, etc.) can cause the terminal to enter an "Out of Service" condition!
2. Open the outer fascia panel to gain access to the security container door, using the key lock on the front of the panel. Open the combination lock on the security container door and open the door to gain access to the dispensing mechanism.
3. To remove the note tray, grasp the tray handle and slide the tray out of the mechanism.

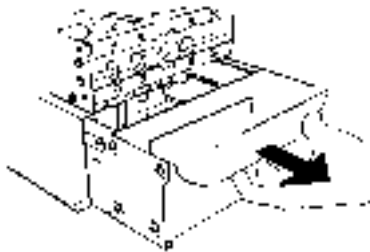

Removing a note tray from the dispensing mechanism.

Removing Rejected Notes

The reject compartment is located nearest the handle side of the note tray. Check the compartment for rejected notes. Remove any notes present.

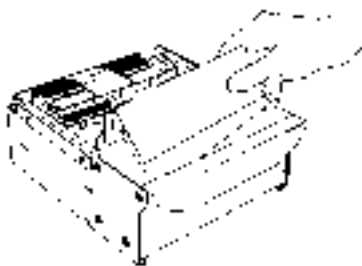

Removing rejected notes.

****WARNING****

DO NOT RECYCLE REJECTED NOTES INTO A CASSETTE! Doing so could cause more rejects and/or currency jams.

You may wish to record the denomination and number of notes for use when balancing the note tray against the tray/day close records.

Loading the Note Tray

1. Move the pusher plate to the rear of the tray (toward the handle). Ensure the pusher plate is fully back. Maintain pressure on the pusher plate as needed while loading notes.

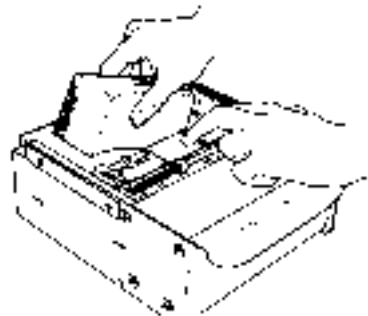

Loading note tray with currency.

2. **IMPORTANT:** The shape of some notes may be affected by conditions of storage or bundling, preventing them from forming neat, even piles. If not corrected, such conditions may cause notes to be rejected by the dispensing mechanism.

To compensate for the most common conditions of slanting or cupped note piles, follow the directions given next.

Notes with no apparent shape problems are referred to as "common" notes.

- **Slanting pile**

To avoid dispensing problems caused by a "slanting" pile, put the notes in neat bundles of no more than $\frac{1}{2}$ to $\frac{3}{4}$ inches in thickness (100-200 notes). Turn every other bundle around to minimize slanting of the pile (bundle should have the same height on both sides, if possible).

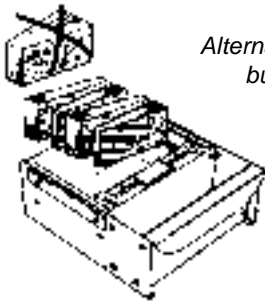

Alternate slanted bundles.

- **Cupped bundle**

To avoid dispensing problems caused by cupped bundles, turn all the bundles with the cupped side towards the dispense opening of the note tray (opposite end from the handle).

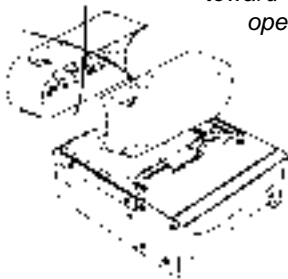

Turn cupped sides toward dispense opening.

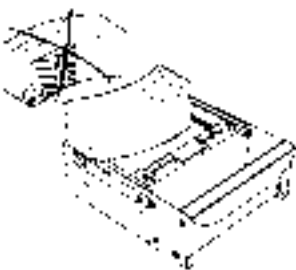

- **Mixed (Slanting and Cupped) bundles**

Separate the mixed currency into neat bundles of 100-200 notes of each type. Place the cupped bundles nearest the dispense opening of the tray, with the cupped side facing the opening. Turn every other slanted bundle around to give the bundles the same height on both sides and place after the cupped bundles.

- **Old and New Notes**

Always place the bundles containing old notes into the cassette first (nearest the handle) and bundles containing new notes last (nearest the dispense opening).



Place old notes together.

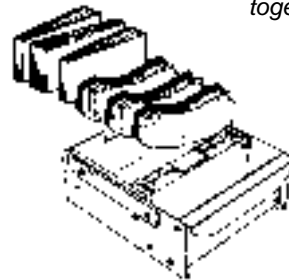

Compensating for various note conditions.

- **Common notes**

Simply place the prepared bundles in the tray.

3. Make sure the note pile is as even as possible. If necessary, use your hands to smooth and level the pile.



Level the note pile.

4. Release the pusher plate against the notes. When loading the note tray to full capacity, make sure that the pusher plate has a leeway of approximately 1/4-inch (5 mm) between the wall plate and the pusher plate .

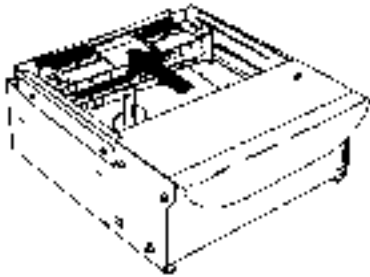

Release packer plate.

5. Using the handle, slide the note tray into the dispensing mechanism. Make sure the note tray is fully inserted!

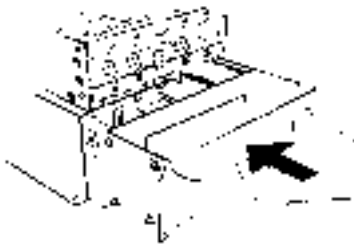

Slide note tray into dispenser mechanism.

6. Close and lock the security cabinet.

MODEL 9750-SERIES**Removing Note Cassettes**

1. UNLOCK the cassettes, using the Cassette Lock/Unlock procedure in Section 5, Management Functions.
2. Open the outer fascia panel of the security container, using the key lock on the front of the panel. Open the combination lock on the security container door and open the door to gain access to the dispensing mechanism.
3. To remove the selected Note Cassette, grasp the cassette handle with one hand while holding the mechanism in place with the other hand. Pull the cassette out slightly. Place one hand underneath to support the cassette as you slide it completely out of the unit.

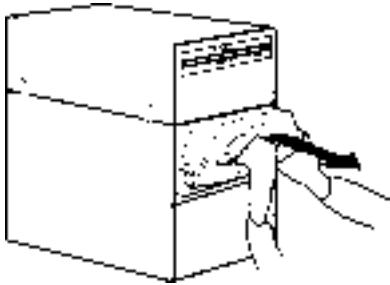
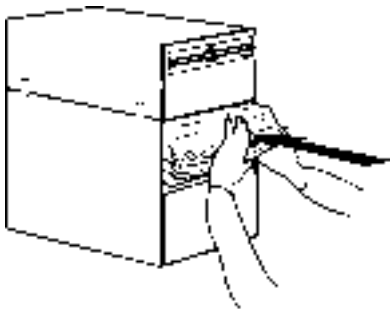
*Removing note cassette.**Replacing note cassette.*

Continue to support the bottom of the cassette to keep it level as you place it on a table or other flat surface.

Opening Note Cassettes

1. Open the cassette by simultaneously pressing the release button and lifting the lid. Flip the lid back fully, allowing it to rest on the table or other flat surface.
2. Move the pusher plate to the rear of the cassette (toward the handle). Ensure the pusher plate is fully back. It should stay in this position.

*Press release button and lift top..**Pull packer plate back.*

Loading Note Cassettes

Follow these steps to load the cassette with notes. When loaded, the notes must lean evenly against the packer plate.

IMPORTANT: The shape of some notes may be affected by conditions of storage or bundling, preventing them from forming neat, even piles. If not corrected, such conditions may cause notes to be rejected by the dispensing mechanism. To compensate for the most common conditions of slanting or cupped note piles, follow the directions given here. Notes with no apparent shape problems are referred to as “common” notes.

- Slanting pile

To avoid dispensing problems caused by a “slanting” pile, put the notes in neat bundles of no more than $\frac{1}{2}$ to $\frac{3}{4}$ inches in thickness. Turn every other bundle around to minimize slanting of the pile.

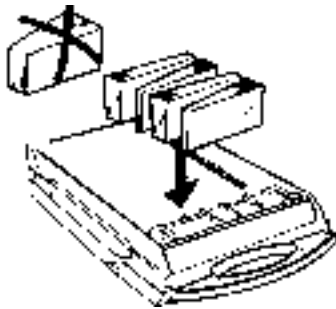

Alternate slanted note piles.

- Cupped bundle

To avoid dispensing problems caused by cupped bundles, turn all the bundles with the cupped side towards the dispense opening (the “feed” end of the cassette).

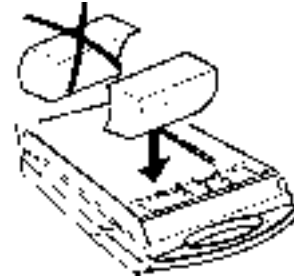

Cupped bundles face dispense opening.

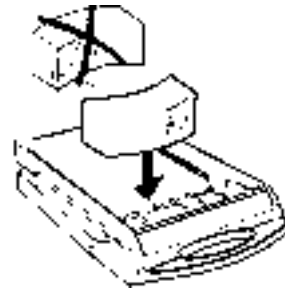

Cupped bundles face dispense opening.

- Common notes

Place the prepared bundles in the cassette.

Follow these steps to load notes in the cassette:

1. Level the note pile. Compress the note pile slightly by hand. Single notes must not protrude from the bundle. Make sure the bundle leans evenly against the note plate.

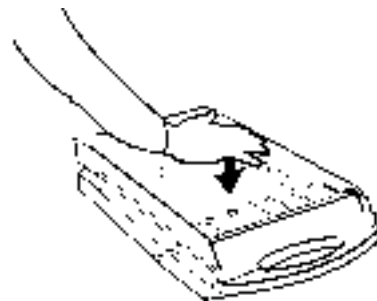

Level the note pile.



Notes lean against packer plate.

2. Move the pusher plate against the notes with just enough pressure to hold the notes in the correct position when closing the lid and inserting the cassette into the mechanism.



Release packer plate.

3. Close the cassette lid. Fold the lid down to its locked position. The release button should “pop” out, allowing the lid to mate cleanly with the body of the cassette.

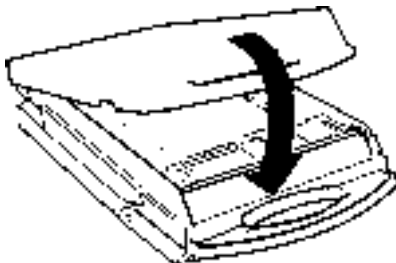

Close cassette top.

Installing Note Cassettes

Once the cassettes have been loaded with currency, replace them using the reverse of the steps used to remove the cassettes from the mechanism. Slide each Note Cassette into its slot in the mechanism. Make sure each cassette is fully inserted.

Once all cassettes have been filled and replaced, they are ready to be LOCKED into position using the Cassette Lock/Unlock function (see Section 5, Management Functions, for the appropriate procedure). **IMPORTANT:** Ensure the MULTIPLE AMOUNT parameter matches the denomination of currency in each Note Cassette! See the procedure for using the VALUE function to set this parameter, in Section 5, Management Functions.

Removing the Reject Vault

The Reject Vault is locked when it is removed from the dispensing mechanism. The color indicator shows a green window when the Reject Vault is opened for note collection (inside the dispensing mechanism) and when it is ready for use.

The color indicator shows a red window when the Reject Vault is inserted into the dispensing mechanism and until it is opened for rejected note retrieval.

1. UNLOCK the cassettes, using the Cassette Lock/Unlock procedure in Section 5, Management Functions.
2. Open the outer fascia panel of the security container, using the key lock on the front of the panel. Open the combination lock on the security container door and open the door to gain access to the dispensing mechanism.

IMPORTANT! If you remove the Reject Vault with power applied, the terminal will sense this and automatically reset the rejected note count to ZERO. Therefore, to ensure an accurate rejected note count **NEVER REMOVE THE REJECT VAULT WITH POWER APPLIED WITHOUT CHECKING FOR AND REMOVING ANY REJECTED NOTES.**

- To remove the Reject Vault, grasp the Vault handle with one hand while holding the mechanism in place with the other hand. Pull the Vault out slightly. Place one hand underneath to support the Vault as you slide it completely out of the unit. Place it on a level surface.

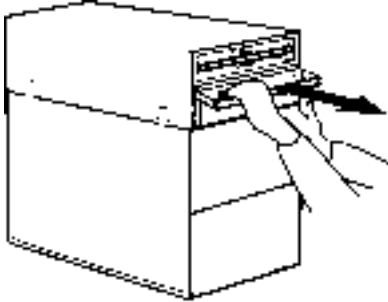

Removing reject vault.

Opening the Reject Vault

The Reject Vault is locked when it is removed from the dispenser. A color indicator window shows GREEN when the vault is opened for collection and when it is ready for use. This condition is also referred to as the PRIME position of the color window.

The color window shows RED when the vault is inserted into the dispenser and will show red until it has been removed from the dispenser and opened for collection.

Remove the vault seal (if applicable). Turn the small handle on the front counterclockwise and lift the lid. Release the handle. Collect the rejected notes.

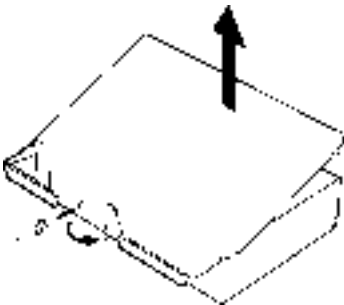

Opening reject vault top.

****WARNING****

DO NOT RECYCLE REJECTED NOTES INTO A CASSETTE! Doing so could cause more rejects and/or currency jams.

Closing the Reject Vault

After removing any rejected notes, turn the small handle about a half-turn counterclockwise and close the lid. Allow the handle to return to the position of the seal bracket. At this point, the vault is primed and the color window should be showing GREEN. If applicable, apply a new vault seal and lock the small handle to the seal bracket.

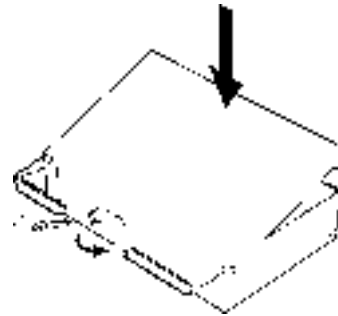

Closing reject vault top.

Installing the Reject Vault

Using the reverse of the steps taken to remove the Reject Vault, slide the Reject Vault back into its slot in the mechanism. Make sure the Vault is fully inserted. LOCK all cassettes into position using the Cassette Lock/Unlock function (see Section 5, Management Functions).

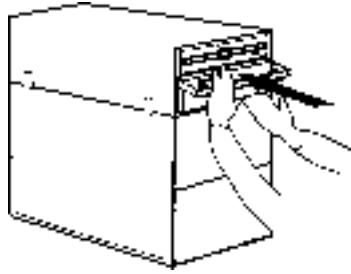

Replacing reject vault.

Verify Operation

1. Close and lock the security cabinet. Restore power to the cash dispenser.
2. Enter quantity of notes in each cassette. Use the ENTER QTY. IN CASSETTE function, in Management Functions.
3. Perform a TRIAL CASSETTE CLOSE on each cassette. Check the Management Report to ensure the quantity value matches what you entered in the previous step.
4. Check the VALUE parameter for each cassette. The Value parameter should match the denomination of the notes in each cassette. Access the Value parameter through Management Functions.
5. Ensure the cassettes are LOCKED.
6. Ensure each note cassette is IN SERVICE.

SECTION 5 - MANAGEMENT FUNCTIONS

INTRODUCTION

This section describes the Management Functions available for controlling the Cash Dispenser. When the CUSTOMER WELCOME screen is displayed, you can access the MANAGEMENT FUNCTIONS menu by following the procedure described next.

ACCESSING THE MANAGEMENT FUNCTIONS MENU

1. Press and hold down the <CTRL> key; while holding down the <CTRL> key, press the <1> key. Release both keys. After a moment the Top Menu will be displayed.
2. At the Top Menu (see figure below), select MANAGEMENT FUNCTIONS.
3. Enter the Master or Administration password at the Password Entry display (see figure below). The factory default MASTER PASSWORD is '123456'. The factory default ADMINISTRATION PASSWORD is '987654'.

When a valid password is entered, the Management Functions menu (see the figure on the next page) will be displayed. Once you have entered the Management Functions Menu you may perform any of the functions allowed by the type of password used.

The ADMINISTRATION password allows access to a limited group of functions such as CLOSE, DIAGNOSTICS, etc. The MASTER PASSWORD allows access to all functions performed with the ADMINISTRATION password plus access to the Cash Dispenser configuration functions.

Each MANAGEMENT FUNCTION description will include the function name, instructions for accessing the function, a factory default value (if applicable) and any error conditions associated with the use of the function.

FUNCTION AVAILABILITY

Some function screens or options described on the following pages may be present but not accessible on your Cash Dispenser. In these cases when you attempt to access the function you will receive a message informing you that the feature or hardware required to support it is not available.

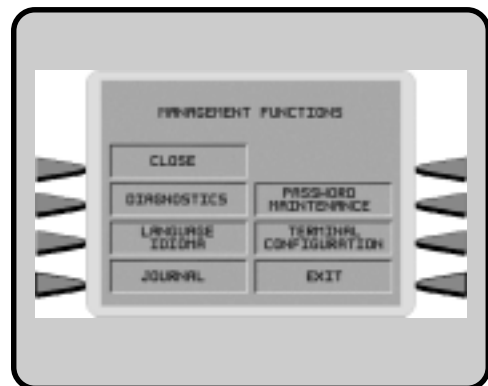

In other cases a function screen or option described here may not even be present in the Management Functions for your particular Cash Dispenser. In such cases this is because the function is not available in the version of terminal operating software currently loaded in the unit.

You may also notice that the factory default values for some functions on your terminal may differ from the values shown in this manual. Again, this is because versions of the terminal operating software customized for a particular processor may require non-standard default values for some parameters.

9700-SERIES	9705-SERIES	9710-SERIES	9750-SERIES
-------------	-------------	-------------	-------------

MANAGEMENT FUNCTIONS

FACTORY DEFAULT: N/A

ACCESS INSTRUCTIONS:

Select the MANAGEMENT FUNCTIONS option from the Top Menu (see page 5-2 for instructions on how to access the Top Menu).

DESCRIPTION:

The MANAGEMENT FUNCTIONS menu offers the following options:

9700-SERIES	9705-SERIES	9710-SERIES	9750-SERIES
-------------	-------------	-------------	-------------

1. CLOSE
2. DIAGNOSTICS
3. LANGUAGE/IDIOMA
4. JOURNAL
5. PASSWORD MAINTENANCE
6. TERMINAL CONFIGURATION

9700-SERIES	9705-SERIES	9710-SERIES	9750-SERIES
-------------	-------------	-------------	-------------

1. CLOSE
2. DIAGNOSTICS
3. LANGUAGE/IDIOMA
4. JOURNAL
5. CASSETTE SERVICE
6. PASSWORD MAINTENANCE
7. TERMINAL CONFIGURATION

ERROR CONDITIONS:

There are no error conditions directly associated with this function.

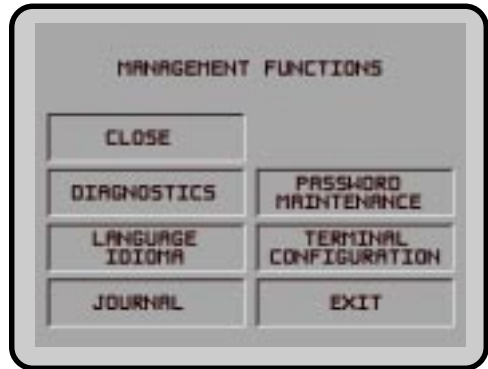

9700, 9705 and 9710-Series Cash Dispensers

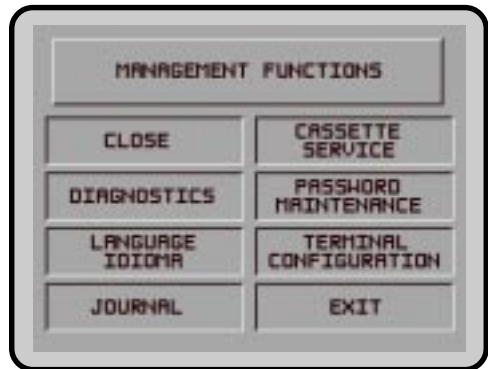

9750-Series Cash Dispensers

9700-SERIES	9705-SERIES	9710-SERIES	9750-SERIES
-------------	-------------	-------------	-------------

CLOSE

FACTORY DEFAULT: N/A

ACCESS INSTRUCTIONS:

Select the CLOSE option from the MANAGEMENT FUNCTIONS screen to view the options available from the SELECT CLOSE FUNCTION menu.

DESCRIPTION:

The SELECT CLOSE FUNCTION menu offers the following options:

9700-SERIES	9705-SERIES	9710-SERIES	9750-SERIES
-------------	-------------	-------------	-------------

1. SCHEDULE CLOSE
2. TRIAL CASSETTE BALANCE
3. TRIAL CLOSE
4. DAY CLOSE
5. SEND TERMINAL TOTALS
6. ENTER QTY. IN CASSETTE
7. CASSETTE CLOSE

9700-SERIES	9705-SERIES	9710-SERIES	9750-SERIES
-------------	-------------	-------------	-------------

1. SCHEDULE CLOSE
2. SEND TERMINAL TOTALS
3. TRIAL CLOSE
4. DAY CLOSE
5. CASSETTE CLOSE
6. TRIAL CASSETTE CLOSE (ALL)

ERROR CONDITIONS:

There are no error conditions directly associated with this function.



**9700, 9705 and 9710-Series
Cash Dispensers**

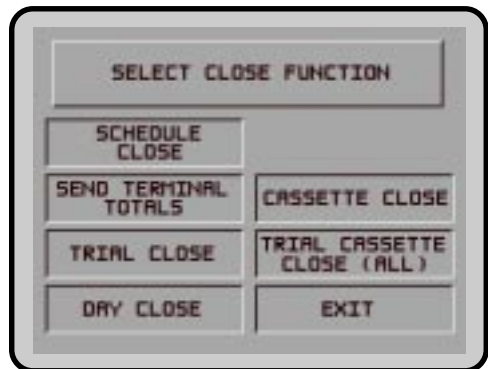

9750-Series Cash Dispensers

9700-SERIES

9705-SERIES

9710-SERIES

9750-SERIES

SCHEDULE CLOSE**FACTORY DEFAULT: OFF****ACCESS INSTRUCTIONS:**

1. Select CLOSE from the MANAGEMENT FUNCTION screen.
2. Select SCHEDULE CLOSE.

DESCRIPTION:

This function allows you to turn on or off the SCHEDULE CLOSE feature. It also provides access to the CHANGE SCHEDULE function, which allows you to specify the time of day when a CLOSE process will be automatically initiated (if the SCHEDULE CLOSE feature is turned ON). When the feature is turned OFF, the close procedure must be initiated manually.

The current state of the SCHEDULE CLOSE feature is shown as either ON or OFF in the label on the left-hand side of the display. Press the button next to this label to toggle the state of the feature between ON and OFF.

NOTE: The close information will be written to the Electronic Journal, allowing it to be printed out, or retrieved by a remote computer equipped with Triton Connect software (version 3.0 or later).

ERROR CONDITIONS:

There are no error conditions directly associated with this function.



9700-SERIES

9705-SERIES

9710-SERIES

9750-SERIES

CHANGE SCHEDULE**FACTORY DEFAULT: N/A****ACCESS INSTRUCTIONS:**

1. Select CLOSE from the MANAGEMENT FUNCTION screen.
2. Select SCHEDULE CLOSE.
3. Select CHANGE SCHEDULE.

DESCRIPTION:

This function is used to set the time, in hours and minutes, at which the terminal will automatically initiate contact with the processor and perform a close operation. The time is entered in the form 'HH:MM:SS' (hours, minutes, seconds). Do not enter the ':' characters separating the fields, just the fields themselves. Press CLEAR to erase everything and start over. Press the BACKSPACE key to back up and erase a single character. Press QUIT to escape without doing anything. Press SET TIME to load the entered time into the clock.

The Cash Dispenser will not let you enter an invalid number for hours or minutes. The clock will properly handle the rollover to the year 2000.

ERROR CONDITIONS:

There are no error conditions directly associated with this function.

TIME SET

	BACKSPACE-->
HH:MM:SS XM	CLEAR-->
	QUIT-->
	SET TIME-->

9700-SERIES

9705-SERIES

9710-SERIES

9750-SERIES

SEND TERMINAL TOTALS**FACTORY DEFAULT: OFF****ACCESS INSTRUCTIONS:**

1. Select CLOSE from the MANAGEMENT FUNCTION screen.
2. Select SEND TERMINAL TOTALS.

DESCRIPTION:

This function allows you to turn on or off the REPORT TERMINAL TOTALS feature. When the feature is turned ON, the terminal will send accumulated totals information to the processor during the close operation. Terminal totals include the total value of all withdrawal, inquiry and transfer transactions that have occurred since the last close operation (see the description of the DAY CLOSE function for additional information).

The current state of the SEND TERMINAL TOTALS feature is shown as either ON or OFF in the label on the left-hand side of the display. Press the button next to this label to toggle the state of the feature between ON and OFF.

ERROR CONDITIONS:

There are no error conditions directly associated with this function.

REPORT TERMINAL TOTALS

WHEN THIS FUNCTION IS ON THE
TERMINAL TOTALS WILL BE
SENT TO THE HOST DURING A
CLOSE PROCEDURE.

REPORT
TOTALS

OFF

EXIT

9700-SERIES 9705-SERIES 9710-SERIES 9750-SERIES

TRIAL CLOSE

FACTORY DEFAULT: N/A

ACCESS INSTRUCTIONS:

1. Select CLOSE from the MANAGEMENT FUNCTIONS screen.
2. Select TRIAL CLOSE.

DESCRIPTION:

The TRIAL CLOSE function is used during the daily close procedure. It does the same thing as DAY CLOSE, except that the totals are not cleared.

The report printed by the TRIAL CLOSE is used to balance your Cash Dispenser before you actually balance with your processor. It contains information obtained from the processor and information that is obtained from the terminal itself.

Typically, you would do a TRIAL CLOSE to get the totals from the Cash Dispenser.

The report shows the total number of customer transactions (Withdrawals, Inquiries and Transfers) recorded by the host processor and the terminal since the last Day Close was performed. The two-column format allows the host and terminal totals in each category to be easily compared. The 'Settlement \$' value is the host processor's record of the total currency dispensed from the terminal since the last Day Close was performed.

ERROR CONDITIONS:

A call to the processor host computer is required to complete the operation. If the call to the host is not completed successfully, a warning (**HOST TOTALS NOT RECEIVED**) will be printed on the report.

** THIS IS LINE 1 OF THE STORE MESSAGE *
 ** THIS IS LINE 2 OF THE STORE MESSAGE *
 ** THIS IS LINE 3 OF THE STORE MESSAGE *
 ** THIS IS LINE 4 OF THE STORE MESSAGE *

Term# 00000000000000

Date: Time:
 03/11/01 10:04:45 AM

TRIAL DAY CLOSE

	HOST	TERMINAL
Withdrawals	100	100
Inquiries	0	0
Transfers	0	0
SETTLEMENT \$	1000.00	1000.00

Sample TRIAL DAY CLOSE receipt.

9700-SERIES 9705-SERIES 9710-SERIES 9750-SERIES

DAY CLOSE

FACTORY DEFAULT: N/A

ACCESS INSTRUCTIONS:

1. Select CLOSE from the MANAGEMENT FUNCTIONS screen.
2. Select DAY CLOSE.

DESCRIPTION:

The DAY CLOSE Function is used to complete daily balancing of the Cash Dispenser with the processor. The DAY CLOSE is performed to clear the totals and switch to the next business day. This function prints a report summarizing all of the activity done by the Cash Dispenser since the last DAY CLOSE was completed. The information includes a total of all transactions.

This function also calls your host processor's computer and commands it to download the totals it has accumulated for the current business day.

The DAY CLOSE is normally completed as the final step in the daily balancing process. The DAY CLOSE report is printed to the receipt printer. The TRIAL CLOSE function does the same thing as the DAY CLOSE, except that the totals are not cleared. See the TRIAL CLOSE function for more information.

NOTE: If the DAY CLOSE is not performed at the same time as the processors' day close, the host and terminal totals may not match.

ERROR CONDITIONS:

A call to the processor host computer is required to complete the operation. If the call to the host is not completed successfully, a warning (**HOST TOTALS NOT RECEIVED**) will be printed on the report.

** THIS IS LINE 1 OF THE STORE MESSAGE *
 ** THIS IS LINE 2 OF THE STORE MESSAGE *
 ** THIS IS LINE 3 OF THE STORE MESSAGE *
 ** THIS IS LINE 4 OF THE STORE MESSAGE *

Term# 00000000000000

Date: Time:
 03/11/01 10:04:45 AM

DAY CLOSE

	HOST	TERMINAL
Withdrawals	100	100
Inquiries	0	0
Transfers	0	0
SETTLEMENT \$	1000.00	1000.00

Sample DAY CLOSE receipt.

9700-SERIES

9705-SERIES

9710-SERIES

9750-SERIES

CASSETTE CLOSE**FACTORY DEFAULT: N/A****ACCESS INSTRUCTIONS:**

1. Select CLOSE from the MANAGEMENT FUNCTIONS screen.
2. Select CASSETTE CLOSE.

DESCRIPTION:

This function is available in 9750-series Cash Dispensers only!

The CASSETTE CLOSE option is used to perform cassette-specific close operations. When the CASSETTE CLOSE option is selected, a cassette selection screen (see the description of the SELECT CASSETTE function for more information) is presented which allows the operator to select the specific cassette which will be the focus of the close operations. The cassette selection screen is followed by the cassette close options screen. The CASSETTE CLOSE option screen provides access to the following functions:

1. TRIAL CASSETTE CLOSE
2. CASSETTE CLOSE
3. ENTER QTY. IN CASSETTE
4. SELECT CASSETTE

ERROR CONDITIONS:

There are no error conditions directly associated with this function.



9700-SERIES 9705-SERIES 9710-SERIES 9750-SERIES

TRIAL CASSETTE CLOSE

FACTORY DEFAULT: N/A

ACCESS INSTRUCTIONS:

9700-SERIES 9705-SERIES 9710-SERIES 9750-SERIES

1. Select CLOSE from the MANAGEMENT FUNCTION screen.
2. Select TRIAL CASSETTE BALANCE.

9700-SERIES 9705-SERIES 9710-SERIES 9750-SERIES

1. Select CLOSE from the MANAGEMENT FUNCTION screen.
2. Select CASSETTE CLOSE. Choose a cassette (A, B, C, or D).
3. Select TRIAL CASSETTE CLOSE.

DESCRIPTION:

Selecting this function prints a receipt summarizing activity on the cassette since the last CASSETTE CLOSE was performed. The totals are not cleared (set to zero) or reported to the host during a trial cassette close.

The following information is provided:

1. **START.** Includes the starting quantity of notes in the cassette, and the total value of this quantity.
2. **DISPENSED.** Shows the number of notes that have been dispensed and the value of this quantity of notes.
3. **REMAINING.** Shows the number of notes remaining in the cassette, and the total value of these notes.
4. **VALUE OF EACH DOC.** The denomination of the notes in the cassette.
5. **TRANSACTIONS.** The number of transactions that have occurred since the last.
6. **REJECTS.** The number of reject events. Rejects can involve more than a single note per event.

ERROR CONDITIONS:

There are no error conditions directly associated with this function.

** THIS IS LINE 1 OF THE STORE MESSAGE *
 ** THIS IS LINE 2 OF THE STORE MESSAGE *
 ** THIS IS LINE 3 OF THE STORE MESSAGE *
 ** THIS IS LINE 4 OF THE STORE MESSAGE *

Term# 00000000000000

Date: Time:
 03/11/01 10:04:45 AM

TRIAL CASSETTE CLOSE

	QTY	AMT
START	500	5000
DISPENSED	100	1000
REMAINING	400	4000
VALUE OF EACH DOC.		\$10.00
TRANSACTIONS:	100	
REJECTS:	0	

Sample TRIAL CASSETTE CLOSE receipt.

9700-SERIES	9705-SERIES	9710-SERIES	9750-SERIES
-------------	-------------	-------------	-------------

CASSETTE CLOSE

FACTORY DEFAULT: N/A

ACCESS INSTRUCTIONS:

9700-SERIES	9705-SERIES	9710-SERIES	9750-SERIES
-------------	-------------	-------------	-------------

1. Select CLOSE from the MANAGEMENT FUNCTION screen.
2. Select CASSETTE CLOSE.

9700-SERIES	9705-SERIES	9710-SERIES	9750-SERIES
-------------	-------------	-------------	-------------

1. Select CLOSE from the MANAGEMENT FUNCTION screen.
2. Select CASSETTE CLOSE. Choose a cassette (A, B, C, or D).
3. Select CASSETTE CLOSE.

DESCRIPTION:

The CASSETTE CLOSE function is used to complete the balancing of a specific currency cassette of the Cash Dispenser. This function prints a report summarizing all activity on the Cash Dispenser for the selected cassette since the last CASSETTE CLOSE was completed. The report includes a total of all transactions.

The CASSETTE CLOSE is normally completed as the final step in balancing the currency cassette before removing it to be replenished. The CASSETTE CLOSE report is printed to the Receipt Printer. Completing a CASSETTE CLOSE clears the cassette total from the Cash Dispenser.

NOTE: The Cassette Close operation also resets the number of bills loaded in the cassette to zero (0). After performing a cassette close, use the "ENTER QTY IN CASSETTE" function to enter the number of bills in the cassette.

ERROR CONDITIONS:

There are no error conditions directly associated with this function.

** THIS IS LINE 1 OF THE STORE MESSAGE *
 ** THIS IS LINE 2 OF THE STORE MESSAGE *
 ** THIS IS LINE 3 OF THE STORE MESSAGE *
 ** THIS IS LINE 4 OF THE STORE MESSAGE *

Term# 0000000000000000

Date: 03/11/01 Time: 10:04:45 AM

CASSETTE CLOSE

	QTY	AMT
START	500	5000
DISPENSED	100	1000
REMAINING	400	4000
VALUE OF EACH DOC.		\$10.00
TRANSACTIONS:	100	
REJECTS:	0	

Sample CASSETTE CLOSE receipt.

9700-SERIES	9705-SERIES	9710-SERIES	9750-SERIES
-------------	-------------	-------------	-------------

ENTER QTY. IN CASSETTE

FACTORY DEFAULT: '0'

ACCESS INSTRUCTIONS:

9700-SERIES	9705-SERIES	9710-SERIES	9750-SERIES
-------------	-------------	-------------	-------------

1. Select CLOSE from the MANAGEMENT FUNCTION screen.
2. Select ENTER QTY. IN CASSETTE.

9700-SERIES	9705-SERIES	9710-SERIES	9750-SERIES
-------------	-------------	-------------	-------------

1. Select CLOSE from the MANAGEMENT FUNCTION screen.
2. Select CASSETTE CLOSE. Choose a cassette (A, B, C, or D).
3. Select ENTER QTY. IN CASSETTE.

DESCRIPTION:

The ENTER QTY. IN CASSETTE function allows entry of the number of documents in the cassette. This number is used as a starting point for the cassette close report. Enter the total number of documents in the cassette and press OK.

NOTE: Enter the number of documents placed in a cassette, not the value of those documents.

ERROR CONDITIONS:

There are no error conditions directly associated with this function.

ENTER THE NUMBER OF BILLS
THAT ARE IN THE CASSETTE NOW
(NOT THE VALUE)

AND THEN PRESS 'OK'

9700-SERIES

9705-SERIES

9710-SERIES

9750-SERIES

SELECT CASSETTE**FACTORY DEFAULT:** 'N/A'**ACCESS INSTRUCTIONS:**

1. Select CLOSE from the MANAGEMENT FUNCTION screen.
2. Select CASSETTE CLOSE. Choose a cassette (A, B, C, or D).
3. Choose the SELECT CASSETTE option.

DESCRIPTION:

This option provides a convenient way to switch between cassettes when performing cassette-specific close operations. Simply select the cassette you wish to work with and a menu of cassette related close functions will be presented. See the description of the CASSETTE CLOSE function for more information.

ERROR CONDITIONS:

There are no error conditions directly associated with this function.



9700-SERIES 9705-SERIES 9710-SERIES 9750-SERIES

TRIAL CASSETTE CLOSE (ALL)

FACTORY DEFAULT: N/A

ACCESS INSTRUCTIONS:

1. Select CLOSE from the MANAGEMENT FUNCTIONS screen.
2. Select TRIAL CASSETTE CLOSE (ALL).

DESCRIPTION:

Selecting the TRIAL CASSETTE CLOSE (ALL) function prints a summary of all cassettes present with out clearing any totals. The host is not contacted.

ERROR CONDITIONS:

There are no error conditions directly associated with this function.

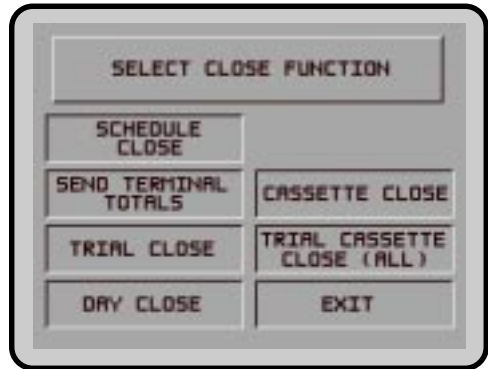

9700-SERIES

9705-SERIES

9710-SERIES

9750-SERIES

DIAGNOSTICS**FACTORY DEFAULT: N/A****ACCESS INSTRUCTIONS:**

Select DIAGNOSTICS from the MANAGEMENT FUNCTIONS screen.

DESCRIPTION:

- Select STATUS to determine the operational status of the four Feed Channels, the Reject Channel and the Transport Channel of the dispensing mechanism.
- Select PURGE to complete a PURGE cycle on the mechanism.
- Select TEST DISPENSE to perform a dispense from each Feed Channel of the mechanism.
- Select FORMAT GRAPHIC MEMORY to erase the memory used to store Ad graphics.
- Select the TEST RECEIPT PRINTER option to test the operation of the Receipt Printer.
- Select the VERSION #'S option to display a screen that provides version numbers for the various components of the terminal operating software.
- Select the MORE DIAGNOSTICS option to access additional diagnostic functions.

The diagnostics options do not have a time-out associated with them. You must manually exit the diagnostics mode when you are finished.

ERROR CONDITIONS:

There are no error conditions directly associated with this function.

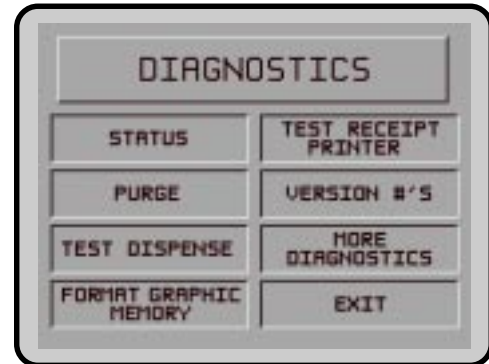

9700-SERIES	9705-SERIES	9710-SERIES	9750-SERIES
-------------	-------------	-------------	-------------

STATUS

FACTORY DEFAULT: N/A

ACCESS INSTRUCTIONS:

1. Select DIAGNOSTICS from the MANAGEMENT FUNCTIONS screen
2. Select the STATUS option.

DESCRIPTION:

The STATUS feature presents a screen with options for initiating status checks on the primary functional areas of the dispensing mechanism.

9700-SERIES	9705-SERIES	9710-SERIES	9750-SERIES
-------------	-------------	-------------	-------------

These areas are the current Status of Count Sensors, the current Double Detect status, the current average thickness of the documents being dispensed, and the current average length of the documents being dispensed. Any of the following sets of return codes will indicate that all of the areas are operating normally:

1. '40 40/50 40 36'
2. '50 40/50 40 36'
3. '44 40/50 40 36'
4. '54 40/50 40 36'

Note that the value of the second number in a set of return codes may be either 40 or 50 (40/50). The cancel button must be pressed to return to the diagnostic's menu.

9700-SERIES	9705-SERIES	9710-SERIES	9750-SERIES
-------------	-------------	-------------	-------------

These areas are the four Feed Channels, the Reject Channel and the Transport Channel. Choose the area you want to check and press the applicable option button. The return code for each of these functional areas of the dispenser will consist of a string of characters that must be interpreted to determine the status of various components within that area. Refer to applicable service documentation for an explanation of these codes. The cancel button must be pressed to return to the DIAGNOSTICS main menu.

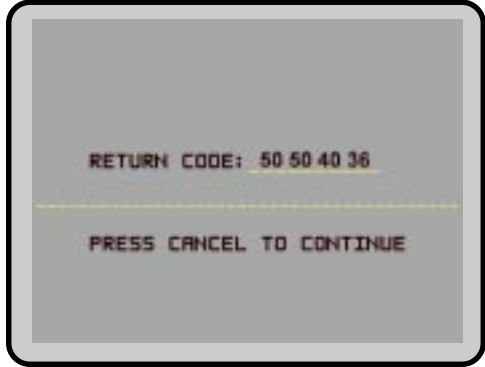

9700, 9705 and 9710-Series Cash Dispensers



9750-Series Cash Dispensers

The Return Code received as a result of initiating status testing may provide indications of error conditions in the specified channel.

ERROR CONDITIONS:

If any code other than what is indicated above is displayed contact your service provider for assistance.

9700-SERIES

9705-SERIES

9710-SERIES

9750-SERIES

PURGE**FACTORY DEFAULT: N/A****ACCESS INSTRUCTIONS:**

1. Select DIAGNOSTICS from the MANAGEMENT FUNCTIONS screen
2. Select the PURGE option.

DESCRIPTION:

When the PURGE option is selected, a PURGE command is sent to the dispenser, instructing it to exercise its note transport system. No notes will be dispensed from the cassettes, but this action should remove any notes that may be present in the transport path of the dispensing mechanism. The return code for a successful PURGE depends upon the model of the Cash Dispenser:

9700, 9705, 9710

The Return Code for a successful purge is '20 20 20'. If any code other than '20 20 20' is displayed, contact your service provider for assistance. Press the cancel key to return to the DIAGNOSTICS main menu.

9750

The Return Code for a successful purge is '0'. If any code other than '0' is displayed, contact your service provider for assistance. Press the cancel key to return to the DIAGNOSTICS main menu.

ERROR CONDITIONS:

The Return Code received as a result of initiating a PURGE command may indicate an error condition in the dispensing mechanism.

RETURN CODE: 20 20 20

PRESS CANCEL TO CONTINUE

**9700, 9705 and 9710-Series
Cash Dispensers**

RETURN CODE: 0

PRESS CANCEL TO CONTINUE

9750-Series Cash Dispensers

9700-SERIES

9705-SERIES

9710-SERIES

9750-SERIES

TEST DISPENSE**FACTORY DEFAULT: N/A****ACCESS INSTRUCTIONS:**

1. Select DIAGNOSTICS from the MANAGEMENT FUNCTIONS screen
2. Select the TEST DISPENSE option.

DESCRIPTION:

The TEST DISPENSE command instructs the dispensing mechanism in the Cash Dispenser to dispense a single note from each Note Cassette, sending each note into the Reject Cassette. This test exercises the dispenser without sending notes to the exit. The return code for a successful TEST DISPENSE depends upon the model of the Cash Dispenser:

9700, 9705, 9710

A return code of '20 20 21' indicates a single successful test dispense. Press the cancel key to return to the diagnostics menu.

9750

The following return codes indicate a successful test dispense:

- 2-Cassette Mechanism: 01100
- 3-Cassette Mechanism: 01110
- 4-Cassette Mechanism: 01111

Press the cancel key to return to the DIAGNOSTICS main menu.

If any code other than what is indicated above is displayed, contact your service provider for assistance

ERROR CONDITIONS:

The Return Code received as a result of initiating a TEST DISPENSE command may indicate an error condition in the dispensing mechanism.

RETURN CODE: 20 20 21

PRESS CANCEL TO CONTINUE

9700-SERIES

9705-SERIES

9710-SERIES

9750-SERIES

FORMAT GRAPHIC MEMORY**FACTORY DEFAULT:** N/A**ACCESS INSTRUCTIONS:**

1. Select DIAGNOSTICS from the MANAGEMENT FUNCTIONS screen.
2. Select the FORMAT GRAPHIC MEMORY option.

DESCRIPTION:

Graphics Memory must be formatted so that it is ready to accept downloaded files from a Triton Connect Host Computer. Graphics Memory is factory formatted. If it becomes necessary to format Graphics Memory, the format operation can be accomplished from either the local terminal or through commands downloaded from a Triton Connect Host Computer.

****CAUTION****

Formatting Graphics Memory will erase all files currently stored in it. Do not format Graphics Memory unless you have the capability to download files to the terminal.

To format Graphics Memory, select YES at the continuation screen. When the FORMAT COMPLETED message appears (see the example figure to the right), press any key to return to the diagnostics main menu.

ERROR CONDITIONS:

There are no error conditions directly associated with this function.



9700-SERIES 9705-SERIES 9710-SERIES 9750-SERIES

TEST RECEIPT PRINTER

FACTORY DEFAULT: N/A

ACCESS INSTRUCTIONS:

1. Select DIAGNOSTICS from the MANAGEMENT FUNCTIONS screen.
2. Select the TEST RECEIPT PRINTER option.

DESCRIPTION:

This command will print two lines of text on the receipt printer and then advance and cut the paper. The text should be 42 characters wide. The remainder of the information on the TEST RECEIPT PRINTER print out is terminal configuration data. If the printer test fails to print two lines of 42 characters, fails to advance the paper, or fails to cut the paper, contact your service provider for assistance. A return code of '00' indicates a successful printer test. Press the cancel key to return to the DIAGNOSTICS main menu.

ERROR CONDITIONS:

If any code other than '00' is displayed contact your service provider for assistance.

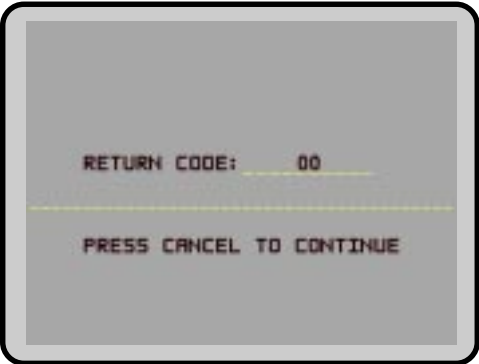

12345678901234567890123456789012
12345678901234567890123456789012

Date: 03/11/01 Time: 10:05:51 AM

Mode: Demo

Term# 0000000000000000
Terminal Owner:

Eprom Version: SD02.02B60 05/24/99

Program Version: SA-DEMO.14 10/19/99

Table Version: ST-9700.14 10/12/99

SPED version: SP-01.00

MACing is Disabled
Printed date format: MMDDYY
Language is ENGLISH

Quad serial board is installed
EPROM does support quad serial board
LED sign is not installed

Mkey index: 0
PIN Master Key Check Digits: E72B0A
PIN Working Key Check Digits: 8CA64D

Primary Phone Number: 5555555
Secondary Phone Number:
Compuserve Routing ID:
Touch Tone, 1200 Baud, Dial Rate: 70
7 data bits, even parity

Surcharging is disabled

Surcharge Owner:
Surcharge Amount: 1.00 % 0

Bill Size: 10.00
Maximum Withdrawal Amount: 500.00
Cassette Low Checking is disabled

Fast Cash Amounts:
10.00
20.00
30.00
40.00
50.00

Prize Coupon printing is disabled

Level prize amount: 50.00
Random prize %: 100

Minimum lines per receipt: 35

CHECKING is spelled: CHECKING

Dispense Counter: 2193

Double Encryption is disabled

Optional Receipt Printing is disabled

Low paper checking is disabled

Bill size checking is enabled

Extended amount is disabled

Status monitoring is disabled

Heartbeat is disabled

AD screens are enabled

Eceipt graphics are enabled

Latin-American style receipt is disabled

Scheduled day close is disabled

Sample RECEIPT PRINTER test results.

9700-SERIES

9705-SERIES

9710-SERIES

9750-SERIES

VERSION #'S**FACTORY DEFAULT:** N/A**ACCESS INSTRUCTIONS:**

1. Select DIAGNOSTICS from the MANAGEMENT FUNCTIONS screen.
2. Select the VERSION #'S option.

DESCRIPTION:

This function displays the version information for the terminal software that is running in the Cash Dispenser. Normally you do not need to access this function unless you are asked to by service personnel.

ERROR CONDITIONS:

There are no error conditions directly associated with this function.

PRESS ANY KEY TO CONTINUE

Version Date

EPR01
PROGRAM
TABLE

9700-SERIES

9705-SERIES

9710-SERIES

9750-SERIES

MORE DIAGNOSTICS**FACTORY DEFAULT: N/A****ACCESS INSTRUCTIONS:**

1. Select DIAGNOSTICS from the MANAGEMENT FUNCTIONS screen.
2. Select the MORE DIAGNOSTICS option.

DESCRIPTION:

For **9700-series**, **9705-series** and **9710-series** Cash Dispensers, the MORE DIAGNOSTICS menu offers the following options:

1. RESET/TEST MODEM, which performs a functional test of the modem hardware.
2. MODEM SPEAKER, which lets you turn the modem speaker sound on or off. Press the keypad button next to the label to toggle the state of the modem speaker between ON and OFF.
3. SCAN CARD, which enables you to test a customer's ATM or credit card for proper operation in the terminal card reader.

For **9750-series** Cash Dispensers, the the SELECT CLOSE FUNCTION menu provides the following options:

1. INJECT NEW CASSETTE ID, which enables you to change the identification code of a cassette.
2. RESET/TEST MODEM, which performs a functional test of the modem hardware.
3. MODEM SPEAKER, which lets you turn the modem speaker sound on or off. Press the keypad button next to the label to toggle the state of the modem speaker between ON and OFF.
4. FORCE UNLOCK CASSETTES, which allows you to override the normal cassette unlocking mechanism.
5. SCAN CARD, which enables you to test a customer's ATM or credit card for proper operation in the terminal card reader.

ERROR CONDITIONS:

There are no error conditions directly associated with this function.



**9700, 9705 and 9710-Series
Cash Dispensers**

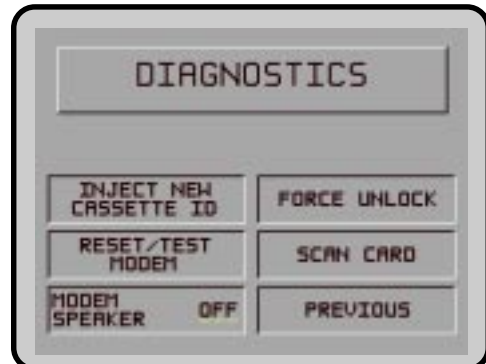

9750-Series Cash Dispensers

9700-SERIES

9705-SERIES

9710-SERIES

9750-SERIES

INJECT NEW CASSETTE ID**FACTORY DEFAULT: N/A****ACCESS INSTRUCTIONS:**

1. Select DIAGNOSTICS from the MANAGEMENT FUNCTIONS screen.
2. Select the MORE DIAGNOSTICS option.
3. Select the INJECT NEW CASSETTE ID option.

DESCRIPTION:

Each Note Cassette contains onboard memory that enables it to store its own identification code. This option allows you to inject a new ID into a Note Cassette. This option will prompt you to insert the cassette you want to use into the top feed channel, and will then provide options for injecting a designation of 'A', 'B', 'C', or 'D' into the cassette in this position. When the ID has successfully been injected, the word DONE will appear. If the operation fails, an error message will be displayed.

The CASSETTE ID has no direct correlation to the physical position of the cassette within the unit, although in most instances the cassette identified as 'A' will be placed in the top position, 'B' in the second, 'C' in the third, and 'D' in the fourth position. This is not a requirement, however, since the ID code allows the dispensing mechanism (and the Cash Dispenser control system) to locate the cassette no matter which slot it is in.

This function will automatically perform an UNLOCK operation so that the cassettes can be rearranged as needed to facilitate the operation. At the conclusion of the procedure, after each cassette has been placed in its appropriate location, use the LOCK/UNLOCK function to LOCK the cassettes into place.

ERROR CONDITIONS:

If the operation fails, an error message will be displayed.

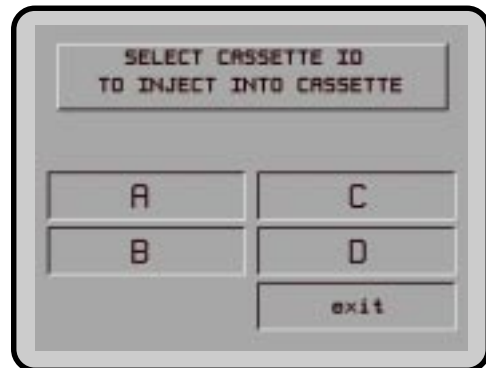

9700-SERIES

9705-SERIES

9710-SERIES

9750-SERIES

RESET/TEST MODEM**FACTORY DEFAULT: N/A****ACCESS INSTRUCTIONS:**

1. Select DIAGNOSTICS from the MANAGEMENT FUNCTIONS screen.
2. Select MORE DIAGNOSTICS.
3. Select the RESET/TEST MODEM option.

DESCRIPTION:

This test confirms that the CPU Module can communicate with the modem and that the modem can be configured. This test does not test the ability of the modem to communicate on the phone line. If the RESET/TEST MODEM TEST fails, contact your service provider for assistance. Press the cancel key to return to the diagnostic's menu.

If the test is successful, the following message screen will be displayed:

ERROR CONDITIONS:

If the test fails, an error message will be displayed.



```
MODEM TESTING / INITIALIZATION
IN PROGRESS

PLEASE WAIT
```



```
MODEM CONFIGURED
AND
TESTED OK

PRESS CANCEL TO CONTINUE
```

9700-SERIES

9705-SERIES

9710-SERIES

9750-SERIES

FORCE UNLOCK CASSETTE**FACTORY DEFAULT: N/A****ACCESS INSTRUCTIONS:**

1. Select the DIAGNOSTICS option from the MANAGEMENT FUNCTIONS menu.
2. Select MORE DIAGNOSTICS.
3. Select FORCE UNLOCK CASSETTE.

DESCRIPTION:

This function provides a means of overriding the unlocking mechanism associated with a particular cassette. It is only to be used immediately after failure of a normal cassette unlock operation.

Occasionally a condition may occur that prevents a cassette from being removed from the dispensing mechanism. A note that is lodged or jammed in a cassette's "gate" could cause such a condition, for example. The gate is a mechanical shutter on the feed end of a cassette, which lowers to allow notes to be dispensed, and raises as a security precaution when the cassette is removed from the dispensing mechanism.

During a normal unlocking operation (see the description of the CASSETTE PARAMETERS function), when the gate is closed the cassette releases an associated mechanical latch, allowing the cassette to be removed from the body of the dispensing mechanism. If the gate does not fully close, the cassette will not release the latch and the cassette will remain locked in the mechanism.

If you find that a particular cassette cannot be removed after performing the normal unlock operation, do not attempt any other action, such as a Cash Dispenser reset, or make multiple attempts to perform a normal unlock operation. The FIRST STEP after encountering a problem with a normal unlock operation is to use the FORCE UNLOCK function to attempt to release the applicable cassette from the mechanism.

To initiate a FORCE UNLOCK operation on a specific cassette, select the option button on the menu that corresponds to the location of the affected cassette.

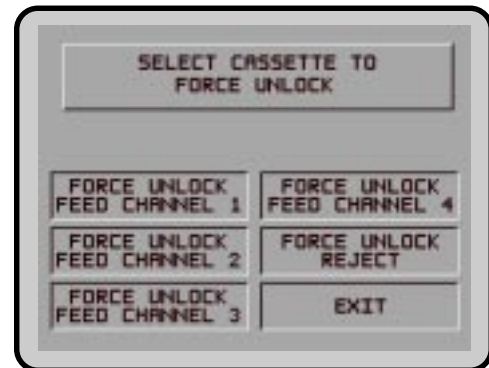

Once the cassette has been removed from the dispensing mechanism, gently remove any notes that are sticking out of the cassette. Re-insert the cassette into the dispensing mechanism and perform a normal LOCK operation, followed by a normal UNLOCK operation. You may now remove and replenish the cassette as normal.

ERROR CONDITIONS:

If the FORCE UNLOCK operation is unsuccessful, contact your Triton authorized sales and service provider.

9700-SERIES	9705-SERIES	9710-SERIES	9750-SERIES
-------------	-------------	-------------	-------------

SCAN CARD

FACTORY DEFAULT: N/A

ACCESS INSTRUCTIONS:

1. Select DIAGNOSTICS from the MANAGEMENT FUNCTIONS screen.
2. Select MORE DIAGNOSTICS.
3. Select the SCAN CARD option.

DESCRIPTION:

The SCAN CARD function reads a card and displays the information imprinted on its magnetic strip. This can be done on a customer card that doesn't seem to work in the Cash Dispenser. If the customer complains of card read errors, first make sure that he or she is inserting the card correctly. Then try to read the card with SCAN CARD. If the card can be read properly, the information from track 1 and track 2 will be displayed. A card need only have a readable track 2 to operate successfully in the Cash Dispenser.

A series of prompt screens direct the user to first INSERT the card to be scanned (shown above) and then to REMOVE it, after which the results of the scan are presented, as shown in the following:

ERROR CONDITIONS:

If the card is damaged or not a standard format, the screen will display an error message. If this happens, the card cannot be used for transactions on the Cash Dispenser.

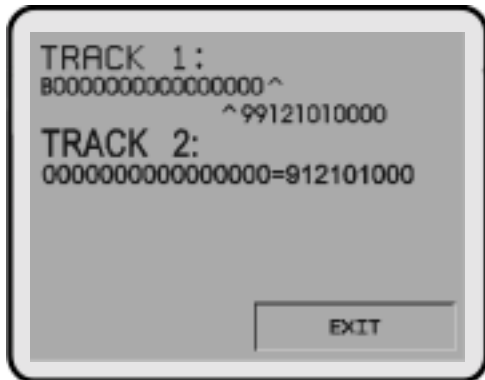

9700-SERIES

9705-SERIES

9710-SERIES

9750-SERIES

LANGUAGE/IDIOMA**FACTORY DEFAULT: COUNTRY-SPECIFIC****ACCESS INSTRUCTIONS:**

Select the LANGUAGE/IDIOMA option from the MANAGEMENT FUNCTIONS screen to view the additional options available.

DESCRIPTION:

This function provides access to the options that control the language that is displayed on the Cash Dispenser LCD Display. Current language options include English or Spanish (certain international versions of terminal software provide a French option instead of Spanish), and a customer option feature enables or disables customer-selection of the language in which text is presented on the LCD display.

1. ENGLISH / INGLES
2. SPANISH / ESPANOL
3. ENABLE CUST. OPTION
4. DISABLE CUST. OPTION

ERROR CONDITIONS:

There are no error conditions directly associated with this function.



9700-SERIES

9705-SERIES

9710-SERIES

9750-SERIES

ENGLISH/INGLES**FACTORY DEFAULT: N/A****ACCESS INSTRUCTIONS:**

1. Select the LANGUAGE / IDIOMA option from the MANAGEMENT FUNCTIONS screen.
2. Select the ENGLISH/INGLES option.

DESCRIPTION:

Choosing this function when the DISABLE CUST. OPTION is selected will set the LCD screen to display only English text during a transaction.

Choosing this function when the ENABLE CUST. OPTION is selected will present customer transaction text in English initially, but will allow the customer to choose English or Spanish (or French for some versions of terminal software).

In addition to the customer transactions taking place in the English language, all Management Functions will be presented in English. All receipts will be printed in English text, as well.

ERROR CONDITIONS:

There are no error conditions directly associated with this function.



9700-SERIES

9705-SERIES

9710-SERIES

9750-SERIES

SPANISH/ESPANOL**FACTORY DEFAULT: N/A****ACCESS INSTRUCTIONS:**

1. Select the LANGUAGE / IDIOMA option from the MANAGEMENT FUNCTIONS screen.
2. Select the SPANISH/ESPANOL option.

DESCRIPTION:

NOTE: Some versions of international software replace the Spanish language option with French.

Choosing this option when the DISABLE CUST. OPTION is selected will display only Spanish text during a transaction.

Choosing this option when the ENABLE CUST. OPTION is selected will give the customer the option of completing the transaction in either English or Spanish.

In addition to the transaction taking place in the Spanish language, all Management Functions will be presented in Spanish.

Some terminal software versions support the printing of receipts in Spanish.

ERROR CONDITIONS:

There are no error conditions directly associated with this function.



9700-SERIES

9705-SERIES

9710-SERIES

9750-SERIES

ENABLE/DISABLE CUST. OPTION**FACTORY DEFAULT: 'OPTION IS: DISABLED'****ACCESS INSTRUCTIONS:**

1. Select the LANGUAGE / IDIOMA option from the MANAGEMENT FUNCTIONS screen.
2. Select either option, as appropriate:

ENABLE CUST. OPTION.
 DISABLE CUST. OPTION.

DESCRIPTION:

If the mode is ENABLED, the customer will be offered a bilingual screen instructing them to select a desired language (currently English and either Spanish or French depending upon software version) for the transaction. If the mode is DISABLED, the customer will not be offered this option.

ERROR CONDITIONS:

There are no error conditions directly associated with this function.



9700-SERIES

9705-SERIES

9710-SERIES

9750-SERIES

JOURNAL**FACTORY DEFAULT:** N/A**ACCESS INSTRUCTIONS:**

Select JOURNAL from the options available at the MANAGEMENT FUNCTIONS screen.

DESCRIPTION:

Select the JOURNAL function from the MANAGEMENT FUNCTIONS screen to:

1. PRINT THE JOURNAL
2. CLEAR JOURNAL
3. PRINT THE LAST X ENTRIES

ERROR CONDITIONS:

There are no error conditions directly associated with this function.

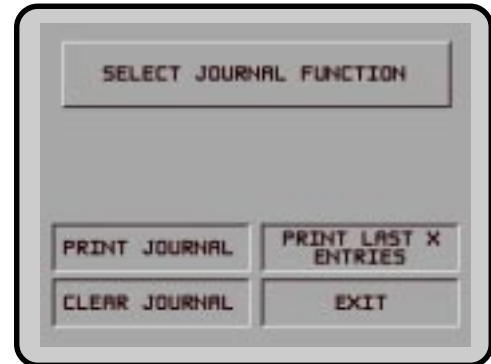

9700-SERIES

9705-SERIES

9710-SERIES

9750-SERIES

PRINT JOURNAL**FACTORY DEFAULT: N/A****ACCESS INSTRUCTIONS:**

1. Select JOURNAL from the options available at the MANAGEMENT FUNCTIONS screen.
2. Select the PRINT JOURNAL option to print all unaudited records stored in the Electronic Journal.

DESCRIPTION:

The PRINT JOURNAL command is used to automatically print out any journal entries collected since the last time the journal was printed. ALL journal records will be printed, whether there are 1 or 2045 records. This command should be used regularly to print the audit trail of the terminal. This information should be maintained in case of an inquiry by a customer, and can also be useful in certain troubleshooting situations.

When this command is run, all unaudited records in the Electronic Journal are immediately sent to the receipt printer, and subsequently marked as audited. Any record printed in this fashion will not be printed again by this command, although it can be printed using the PRINT LAST X ENTRIES command. When the journal has finished printing, the SELECT JOURNAL FUNCTION screen will be displayed.

ERROR CONDITIONS:

If the operation fails, an error message will be displayed.

JOURNAL
PRINTING
PLEASE WAIT
ENSURE JOURNAL CLEARS BOTTOM
OF PAPER CHUTE

9700-SERIES

9705-SERIES

9710-SERIES

9750-SERIES

CLEAR JOURNAL**FACTORY DEFAULT: N/A****ACCESS INSTRUCTIONS:**

1. Select JOURNAL from the options available at the MANAGEMENT FUNCTIONS screen.
2. Select the CLEAR JOURNAL option to mark all journal entries stored in the Electronic Journal since the last time the CLEAR JOURNAL or PRINT JOURNAL functions were completed.

DESCRIPTION:

The CLEAR JOURNAL command is used to mark all unprinted records in the journal as 'audited'. This means that they will not be printed out the next time a PRINT JOURNAL command is performed. Audited records are not erased. They are marked as if they had been printed. When this function is selected, a confirmation screen prompts the user to answer YES, CLEAR to continue with operation or NO, CANCEL to quit. If the user answers YES, CLEAR, the following screen will be displayed:

When the journal has been cleared, the SELECT JOURNAL FUNCTION screen will be displayed. Note that even after this command has been completed, records are still available for printing by using the PRINT LAST X ENTRIES command.

ERROR CONDITIONS:

If the operation fails, an error message will be displayed.

CLEARING
JOURNALALL RECORDS WILL BE MARKED
AS AUDITED

DO YOU WISH TO CONTINUE?

NO- CANCEL

YES- CLEAR

CLEARING
JOURNAL

PLEASE WAIT

9700-SERIES

9705-SERIES

9710-SERIES

9750-SERIES

PRINT LAST X ENTRIES**FACTORY DEFAULT:** N/A**ACCESS INSTRUCTIONS:**

1. Select JOURNAL from the options available at the MANAGEMENT FUNCTIONS screen.
2. Select the PRINT LAST X ENTRIES option to print the last X (where 'X' is a number from 1 to 2045) entries stored in the Electronic Journal.

DESCRIPTION:

This command is used to reprint records from the Electronic Journal, either before or after they have been audited using the CLEAR JOURNAL or PRINT JOURNAL commands. Records printed out using this command are not marked in any way. This command will not affect the operation of the PRINT JOURNAL command.

This command is used for several purposes. It can be used to reprint records for which the paper trail has been lost or destroyed. It can also be used to print out records before they are audited, for diagnostic purposes.

When using this command, the user is prompted to enter the number of the most recently collected records to be printed. It always operates on the last 'X' entries. If an operator needs to see a transaction that happened about 10 records earlier, entering '13' at the prompt will cause the last 13 records to be printed, but not cleared, from the buffer. This will ensure that the transaction in question is printed.

Subsequent uses of this command are not cumulative. No pointer is maintained that 'moves' each time this command is run. It always operates on the LAST X ENTRIES.

ERROR CONDITIONS:

Entering a number greater than the number of records in the buffer memory of the journal will cause all records to be printed. The buffer memory can contain up to 2045 records at any one time.

ENTER THE NUMBER OF RECORDS

TO PRINT

AND THEN PRESS 'OK'

9700-SERIES

9705-SERIES

9710-SERIES

9750-SERIES

CASSETTE SERVICE**FACTORY DEFAULT: N/A****ACCESS INSTRUCTIONS:**

Select the CASSETTE SERVICE option from the MANAGEMENT FUNCTIONS screen.

DESCRIPTION:

The CASSETTE SERVICE option provides the terminal operator with the ability to quickly lock and unlock cassettes, or to place selected cassettes into service. The cassette selection screen provides an option button for each cassette: A, B, C, or D. Press the desired button to place that cassette in service. Press the indicated button to lock or unlock all of the cassettes. Note that the current lock status of the cassettes is shown in the lower left label area.

Once a cassette is in service, the following message will be displayed: Press any key to return to the main Management Functions menu.

ERROR CONDITIONS:

There are no error conditions directly associated with this function.

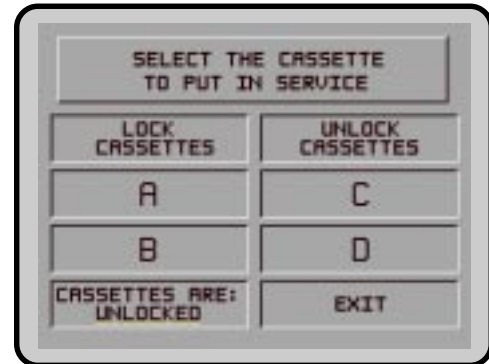

9700-SERIES

9705-SERIES

9710-SERIES

9750-SERIES

PASSWORD MAINTENANCE**FACTORY DEFAULT:** N/A**ACCESS INSTRUCTIONS:**

Select the PASSWORD MAINTENANCE option from the MANAGEMENT FUNCTIONS screen.

DESCRIPTION:

The PASSWORD MAINTENANCE Function of MANAGEMENT FUNCTIONS menu allows access to menus for viewing and changing the following:

1. MASTER PASSWORD
2. ADMINISTRATION PASSWORD

ERROR CONDITIONS:

There are no error conditions directly associated with this function.

PASSWORD MAINTENANCE

MASTER
PASSWORDADMINISTRATION
PASSWORD

EXIT

9700-SERIES

9705-SERIES

9710-SERIES

9750-SERIES

MASTER PASSWORD**FACTORY DEFAULT:** '123456'**ACCESS INSTRUCTIONS:**

1. Select the PASSWORD MAINTENANCE option from the MANAGEMENT FUNCTIONS screen.
2. Select the MASTER PASSWORD option.

DESCRIPTION:

The MASTER PASSWORD is the highest level password on the Cash Dispenser. It allows access to all functions except downloading of new software. The MASTER PASSWORD must be entered in order to change the ADMINISTRATION password. The factory default MASTER PASSWORD is '123456' and should be changed when the Cash Dispenser is installed.

To change the MASTER PASSWORD, select this function. You will be prompted to enter your new password. An asterisk (*) will be displayed in place of the actual digits entered; therefore, you must enter the password a second time when prompted to confirm it.

The password can be from 4 to 12 digits long and can contain only numbers; letters are not allowed.

ERROR CONDITIONS:

A number of feedback screens may appear during password entry. These screens can appear if the second password entry did not match the first, you entered an invalid password, or the password you entered was too short (less than 4 characters).



9700-SERIES	9705-SERIES	9710-SERIES	9750-SERIES
-------------	-------------	-------------	-------------

ADMINISTRATION PASSWORD

FACTORY DEFAULT: '987654'

ACCESS INSTRUCTIONS:

1. Select the PASSWORD MAINTENANCE option from the MANAGEMENT FUNCTIONS screen.
2. Select the ADMINISTRATION PASSWORD option.

DESCRIPTION:

The ADMINISTRATION PASSWORD is used to perform daily management functions. This password DOES NOT allow access to the TERMINAL CONFIGURATION menu.

This password can only be changed when the MASTER PASSWORD is used to enter the Management FUNCTIONS area. Use the options provided to VIEW or CHANGE the password, as shown in the figures below. When the VIEW option is selected, the current password will be displayed for a few seconds. When changing the password, it must be entered twice, because the characters entered are not displayed (an asterisk (*) is displayed in place of each character, for security reasons). The password length can range from 4 to 12 characters.

ERROR CONDITIONS:

A number of feedback screens may appear during password entry. These screens can appear if the second password entry did not match the first, you entered an invalid password, or the password you entered was too short (less than 4 characters).



VIEW



CHANGE

9700-SERIES

9705-SERIES

9710-SERIES

9750-SERIES

TERMINAL CONFIGURATION**FACTORY DEFAULT:** N/A**ACCESS INSTRUCTIONS:**

Select the TERMINAL CONFIGURATION option from the MANAGEMENT FUNCTIONS screen.

DESCRIPTION:

The TERMINAL CONFIGURATION option provides access to functions that allow the following parameters to be viewed and changed:

1. PRINTER SETTINGS
2. RANDOM/LEVEL PRIZE COUPONS
3. CHANGE MESSAGES
4. SET TERMINAL PARAMETERS
5. DATE / TIME FUNCTIONS
6. TRANSACTION TYPES
7. ACCOUNT TYPES

ERROR CONDITIONS:

There are no error conditions directly associated with this function.

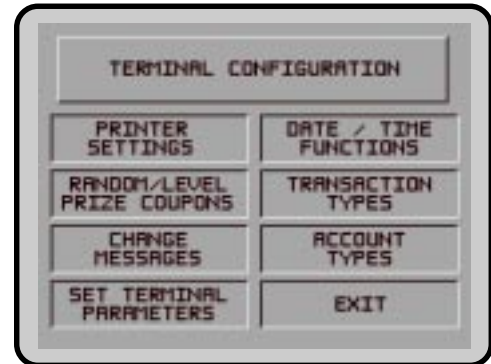

9700-SERIES

9705-SERIES

9710-SERIES

9750-SERIES

PRINTER SETTINGS**FACTORY DEFAULT:** N/A**ACCESS INSTRUCTIONS:**

1. Select the TERMINAL CONFIGURATION option from the MANAGEMENT FUNCTIONS screen.
2. Select the PRINTER SETTINGS option.

DESCRIPTION:

This menu provides access to the following functions:

1. SET PRINT LENGTH
2. LOW RECEIPT PAPER
3. PRINTER GRAPHICS

ERROR CONDITIONS:

There are no error conditions directly associated with this function.



9700-SERIES

9705-SERIES

9710-SERIES

9750-SERIES

SET PRINT LENGTH**FACTORY DEFAULT: '35'****ACCESS INSTRUCTIONS:**

1. Select the TERMINAL CONFIGURATION option from the MANAGEMENT FUNCTIONS screen.
2. Select the PRINTER SETTINGS option.
3. Select SET PRINT LENGTH.

DESCRIPTION:

This function sets the minimum length of the receipt provided to the customer after each transaction.

ERROR CONDITIONS:

Changing the Print Length to less than 35 lines will prevent the receipt from exiting the front of the Cash Dispenser. This may cause paper jams that could result in printer damage.

MINIMUM PRINT LENGTH:
(NUMBER OF LINES PER RECEIPT)

ENTER MIN. # LINES (0-99)

CHANGE

EXIT

9700-SERIES

9705-SERIES

9710-SERIES

9750-SERIES

LOW RECEIPT PAPER**FACTORY DEFAULT: 'OUT OF SERVICE'****ACCESS INSTRUCTIONS:**

1. Select TERMINAL CONFIGURATION from the MANAGEMENT FUNCTIONS menu.
2. Select the PRINTER SETTINGS option.
3. Choose the LOW RECEIPT PAPER option.

DESCRIPTION:

After selecting the LOW RECEIPT PAPER ON/OFF option, a screen displaying, "WHEN RECEIPT PAPER BECOMES LOW, THE ATM WILL BE OUT OF SERVICE" (or IN SERVICE depending on terminal setup). Change to IN SERVICE or OUT OF SERVICE by pressing the Screen Key next to the appropriate text and pressing the EXIT key.

Selecting the IN SERVICE options will allow the terminal to continue to operate after it senses a Receipt Printer Paper Low condition (Error Code 183). Selecting this option will allow the terminal to operate with low or no receipt paper in the terminal.

Selecting the OUT OF SERVICE option will allow the terminal to report a Receipt Printer Paper Low condition (Error Code 183), and will place the terminal in an OUT OF SERVICE condition until the receipt paper is replenished.

ERROR CONDITIONS:

Error Code 183 – Receipt Printer Paper Low will take the terminal OUT OF SERVICE. To restore the terminal to normal operation the paper must be replenished and the Reset Error button pressed after the terminal has been reset and is displaying the OUT OF SERVICE screen.



9700-SERIES

9705-SERIES

9710-SERIES

9750-SERIES

PRINTER GRAPHICS**FACTORY DEFAULT: ENABLED****ACCESS INSTRUCTIONS:**

1. Select TERMINAL CONFIGURATION option from the MANAGEMENT FUNCTIONS screen.
2. Select the PRINTER SETTINGS option.
3. Select PRINTER GRAPHICS.

DESCRIPTION:

The Printed Graphics feature can only be used when an optional Memory Expansion Card is installed in the terminal. Triton Connect Software Release 1.8 (or above) allows bit mapped graphics (in '.bmp' format) to be downloaded to the terminal. This graphic will be printed on the receipt when the PRINTER GRAPHICS option has been ENABLED. This feature cannot be supported without the addition of an Expansion Memory Card.

To turn on the PRINTER GRAPHICS feature, choose the ENABLE option on this screen. To inhibit the PRINTER GRAPHICS feature, press the DISABLE key.

ERROR CONDITIONS:

If PRINTER GRAPHICS is enabled and there are no graphic images loaded into the Expansion Memory Card, the receipt printer will print normal receipts without graphics. There are no error conditions associated with this function.

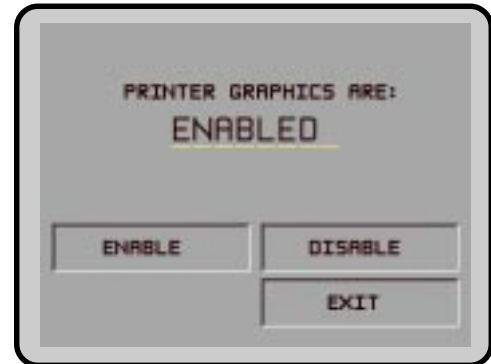

9700-SERIES	9705-SERIES	9710-SERIES	9750-SERIES
-------------	-------------	-------------	-------------

RANDOM/LEVEL PRIZE COUPONS

FACTORY DEFAULT: N/A

ACCESS INSTRUCTIONS:

1. Select TERMINAL CONFIGURATION from the MANAGEMENT FUNCTIONS menu.
2. Select RANDOM/LEVEL PRIZE COUPONS from the TERMINAL CONFIGURATION menu.

DESCRIPTION:

The SELECT COUPON TYPE screen allows the operator to access the functions specific to managing either printed or dispensed prize coupons. The following options are available:

9700-SERIES	9705-SERIES	9710-SERIES	9750-SERIES
-------------	-------------	-------------	-------------

1. ENTER LEVEL PRIZE MESSAGE.
2. ENTER RANDOM PRIZE MESSAGE.
3. ENABLE/DISABLE COUPON AWARDS.
4. SET LEVEL PRIZE AMOUNT.
5. SET RANDOM WINNING %.

9700-SERIES	9705-SERIES	9710-SERIES	9750-SERIES
-------------	-------------	-------------	-------------

1. PRINTED COUPONS.
2. DISPENSED COUPONS.

Printed coupons are delivered to the customer via the receipt printer, while dispensed coupons are dispensed from one or more of the note cassettes.

ERROR CONDITIONS:

There are no error conditions directly associated with this function.



9700-SERIES

9705-SERIES

9710-SERIES

9750-SERIES

PRINTED COUPONS**FACTORY DEFAULT: N/A****ACCESS INSTRUCTIONS:**

1. Select TERMINAL CONFIGURATION from the MANAGEMENT FUNCTIONS menu.
2. Select RANDOM/LEVEL PRIZE COUPONS from the TERMINAL CONFIGURATION menu.
3. Select PRINTED COUPONS.

DESCRIPTION:

This function provides access to the following options, which will set up terminal operations for issuing printed prize coupons:

1. ENTER LEVEL/PRIZE MESSAGE.
2. ENTER RANDOM PRIZE MESSAGE.
3. ENABLE/DISABLE COUPON AWARDS.
4. SET LEVEL PRIZE AMOUNT.
5. SET RANDOM WINNING %.

ERROR CONDITIONS:

There are no error conditions directly associated with this function.



9700-SERIES	9705-SERIES	9710-SERIES	9750-SERIES
-------------	-------------	-------------	-------------

ENTER LEVEL PRIZE MSG.

FACTORY DEFAULT: NONE

ACCESS INSTRUCTIONS:

9700-SERIES	9705-SERIES	9710-SERIES	9750-SERIES
-------------	-------------	-------------	-------------

1. Select TERMINAL CONFIGURATION from the MANAGEMENT FUNCTIONS menu.
2. Select RANDOM/LEVEL PRIZE COUPONS from the TERMINAL CONFIGURATION menu.
3. Select ENTER LEVEL PRIZE MSG.

9700-SERIES	9705-SERIES	9710-SERIES	9750-SERIES
-------------	-------------	-------------	-------------

1. Select TERMINAL CONFIGURATION from the MANAGEMENT FUNCTIONS menu.
2. Select RANDOM/LEVEL PRIZE COUPONS from the TERMINAL CONFIGURATION menu.
3. Select PRINTED COUPONS.
4. Select ENTER LEVEL PRIZE MSG.

DESCRIPTION:

The LEVEL PRIZE MESSAGE consists of four lines of text that are printed on the Level Prize receipt. Enter letters, numbers and punctuation as described in the following paragraphs.

The keys along either side of the display are used with the numeric keys on the main keypad to permit entry of alphanumeric characters. The keys on the left side of the display are designated <F1> through <F4>. The keys on the right side of the display are <F6> through <F8>. The <F1> key centers the text on the line where the cursor appears. The <F2> key erases all text in the current message. <F3> clears the text on the current line.

The <F4> Key is used similarly to a CAPS LOCK key on a computer keyboard. Pressing the <F4> key toggles between uppercase and lowercase. To enter an alphabetic or punctuation character, one of the <F6> through <F8> keys must be pressed, followed by one of the numeric keys. The resultant character will be as indicated in the table. Press the <OK> key to save the changes made. If you make a mistake and want to start over, press the CANCEL key to discard any changes made to that point.

ERROR CONDITIONS:

There are no error conditions directly associated with this function.

F1 CENTER LINE
 F2 CLEAR ALL
 F3 CLEAR LINE
 F4 CASE UPPER

LEFT F6
 CENTER F7
 RIGHT F8

KEY	1	2	3	4	5	6	7	8	9	0
F4 UPPER
No Shift	1	2	3	4	5	6	7	8	9	0
F6 Left	Q	A	D	G	J	M	P	T	W	,
F7 Center	Z	B	E	H	K	N	R	U	X	.
F8 Right	Sp	C	F	I	L	O	S	V	Y	-
F4 LOWER										
No Shift	!	@	#	\$	%	^	&	*	()
F6 Left	q	a	d	g	j	m	p	t	w	'
F7 Center	z	b	c	h	k	n	r	u	x	+
F8 Right	&	c	f	i	l	o	s	v	y	=

9700-SERIES	9705-SERIES	9710-SERIES	9750-SERIES
-------------	-------------	-------------	-------------

ENTER RANDOM PRIZE MSG.

FACTORY DEFAULT: NONE

ACCESS INSTRUCTIONS:

9700-SERIES	9705-SERIES	9710-SERIES	9750-SERIES
-------------	-------------	-------------	-------------

1. Select TERMINAL CONFIGURATION from the MANAGEMENT FUNCTIONS menu.
2. Select RANDOM/LEVEL PRIZE COUPONS from the TERMINAL CONFIGURATION menu.
3. Select ENTER RANDOM PRIZE MSG.

9700-SERIES	9705-SERIES	9710-SERIES	9750-SERIES
-------------	-------------	-------------	-------------

1. Select TERMINAL CONFIGURATION from the MANAGEMENT FUNCTIONS menu.
2. Select RANDOM/LEVEL PRIZE COUPONS from the TERMINAL CONFIGURATION menu.
3. Select PRINTED COUPONS.
4. Select ENTER RANDOM PRIZE MSG.

DESCRIPTION:

The RANDOM PRIZE MESSAGE consists of four lines of text that are printed on the Random Coupon receipt. Enter letters, numbers and punctuation as described in the following paragraphs.

The keys along either side of the display are used with the numeric keys on the main keypad to permit entry of alphanumeric characters. The keys on the left side of the display are designated <F1> through <F4>. The keys on the right side of the display are <F6> through <F8>. The <F1> key centers the text on the line where the cursor appears. The <F2> key erases all text in the current message. <F3> clears the text on the current line.

The <F4> Key is used similarly to a CAPS LOCK key on a computer keyboard. Pressing the <F4> key toggles between uppercase and lowercase. To enter an alphabetic or punctuation character, one of the <F6> through <F8> keys must be pressed, followed by one of the numeric keys. The resultant character will be as indicated in the table. Press the <OK> key to save the changes made. If you make a mistake and want to start over, press the CANCEL key to discard any changes made to that point.

ERROR CONDITIONS:

There are no error conditions directly associated with this function.

F1 CENTER LINE
 F2 CLEAR ALL
 F3 CLEAR LINE
 F4 CASE UPPER

LEFT F6
 CENTER F7
 RIGHT F8

KEY	1	2	3	4	5	6	7	8	9	0
F4 UPPER
No Shift	1	2	3	4	5	6	7	8	9	0
F6 Left	Q	A	D	G	J	M	P	T	W	,
F7 Center	Z	B	E	H	K	N	R	U	X	.
F8 Right	Sp	C	F	I	L	O	S	V	Y	-
F4 LOWER										
No Shift	!	@	#	\$	%	^	&	*	()
F6 Left	q	a	d	g	j	m	p	t	w	'
F7 Center	z	b	c	h	k	n	r	u	x	+
F8 Right	&	c	f	i	l	o	s	v	y	=

9700-SERIES	9705-SERIES	9710-SERIES	9750-SERIES
-------------	-------------	-------------	-------------

ENABLE/DISABLE COUPON AWARDS

FACTORY DEFAULT: DISABLED

ACCESS INSTRUCTIONS:

9700-SERIES	9705-SERIES	9710-SERIES	9750-SERIES
-------------	-------------	-------------	-------------

1. Select TERMINAL CONFIGURATION from the MANAGEMENT FUNCTIONS menu.
2. Select RANDOM/LEVEL PRIZE COUPONS from the TERMINAL CONFIGURATION menu.
3. Select the ENABLE/DISABLE COUPON AWARDS option.

9700-SERIES	9705-SERIES	9710-SERIES	9750-SERIES
-------------	-------------	-------------	-------------

1. Select TERMINAL CONFIGURATION from the MANAGEMENT FUNCTIONS menu.
2. Select RANDOM/LEVEL PRIZE COUPONS from the TERMINAL CONFIGURATION menu.
3. Select PRINTED COUPONS.
4. Select the ENABLE/DISABLE COUPON AWARDS option.

DESCRIPTION:

This function provides access to a menu that allows the operator to ENABLE or DISABLE all printed coupon awards. If ENABLED, eligible transactions will be checked for award. If DISABLED, no coupons will be issued.

ERROR CONDITIONS:

There are no error conditions directly associated with this function.



9700-SERIES	9705-SERIES	9710-SERIES	9750-SERIES
-------------	-------------	-------------	-------------

SET LEVEL PRIZE AMOUNT

FACTORY DEFAULT: '\$0.00'

ACCESS INSTRUCTIONS:

9700-SERIES	9705-SERIES	9710-SERIES	9750-SERIES
-------------	-------------	-------------	-------------

1. Select TERMINAL CONFIGURATION from the MANAGEMENT FUNCTIONS menu.
2. Select RANDOM/LEVEL PRIZE COUPONS from the TERMINAL CONFIGURATION menu.
3. Select the SET LEVEL PRIZE AMOUNT option.

9700-SERIES	9705-SERIES	9710-SERIES	9750-SERIES
-------------	-------------	-------------	-------------

1. Select TERMINAL CONFIGURATION from the MANAGEMENT FUNCTIONS menu.
2. Select RANDOM/LEVEL PRIZE COUPONS from the TERMINAL CONFIGURATION menu.
3. Select PRINTED COUPONS.
4. Select the SET LEVEL PRIZE AMOUNT option.

DESCRIPTION:

This function sets the threshold level at which the level prize coupon will be printed. Withdrawing an amount equal to or greater than the value set here will print the level prize coupon.

To enter a new value, press the CHANGE button, enter a new value, then press <OK>.

NOTE: If the level coupon is awarded, the random coupon parameter will not be tested for award.

ERROR CONDITIONS:

There are no error conditions directly associated with this function.



9700-SERIES	9705-SERIES	9710-SERIES	9750-SERIES
-------------	-------------	-------------	-------------

SET RANDOM WINNING %

FACTORY DEFAULT: '0%'

ACCESS INSTRUCTIONS:

9700-SERIES	9705-SERIES	9710-SERIES	9750-SERIES
-------------	-------------	-------------	-------------

1. Select TERMINAL CONFIGURATION from the MANAGEMENT FUNCTIONS menu.
2. Select RANDOM/LEVEL PRIZE COUPONS from the TERMINAL CONFIGURATION menu.
3. Select the SET RANDOM WINNING % option.

9700-SERIES	9705-SERIES	9710-SERIES	9750-SERIES
-------------	-------------	-------------	-------------

1. Select TERMINAL CONFIGURATION from the MANAGEMENT FUNCTIONS menu.
2. Select RANDOM/LEVEL PRIZE COUPONS from the TERMINAL CONFIGURATION menu.
3. Select PRINTED COUPONS.
4. Select the SET RANDOM WINNING % option.

DESCRIPTION:

This function sets the frequency at which the random prize coupons will be printed. The random coupon is won by a random number of transactions of any type. The winning percentage can be set from 0 to 100%. For example, if the winning percentage is set to 10%, then 1 out of every 10 transactions will be awarded a prize.

To enter a new value, press the CHANGE button, enter a new value, then press <OK>.

ERROR CONDITIONS:

There are no error conditions directly associated with this function.



9700-SERIES

9705-SERIES

9710-SERIES

9750-SERIES

DISPENSED COUPONS**FACTORY DEFAULT: N/A****ACCESS INSTRUCTIONS:**

1. Select TERMINAL CONFIGURATION from the MANAGEMENT FUNCTIONS menu.
2. Select RANDOM/LEVEL PRIZE COUPONS from the TERMINAL CONFIGURATION menu.
3. Select DISPENSED COUPONS.

DESCRIPTION:

This function provides access to the following options, which will set up terminal operations for issuing printed prize coupons:

1. SELECT LEVEL COUPON CASSETTE.
2. SELECT RANDOM COUPON CASSETTE.
3. ENABLE/DISABLE COUPON AWARDS.
4. SET LEVEL PRIZE AMOUNT.
5. SET RANDOM WINNING %.

ERROR CONDITIONS:

There are no error conditions directly associated with this function.



9700-SERIES

9705-SERIES

9710-SERIES

9750-SERIES

SELECT LEVEL COUPON CASS.**FACTORY DEFAULT: N/A****ACCESS INSTRUCTIONS:**

1. Select TERMINAL CONFIGURATION from the MANAGEMENT FUNCTIONS menu.
2. Select RANDOM/LEVEL PRIZE COUPONS from the TERMINAL CONFIGURATION menu.
3. Select DISPENSED COUPONS.
4. Choose SELECT LEVEL COUPON CASS.

DESCRIPTION:

This function allows the operator to select the cassette which will dispense coupons on a withdrawal-level basis.

ERROR CONDITIONS:

There are no error conditions directly associated with this function.



9700-SERIES

9705-SERIES

9710-SERIES

9750-SERIES

SELECT RANDOM COUPON CASS.**FACTORY DEFAULT: N/A****ACCESS INSTRUCTIONS:**

1. Select TERMINAL CONFIGURATION from the MANAGEMENT FUNCTIONS menu.
2. Select RANDOM/LEVEL PRIZE COUPONS from the TERMINAL CONFIGURATION menu.
3. Select DISPENSED COUPONS.
4. Choose SELECT RANDOM COUPON CASS.

DESCRIPTION:

This function allows the operator to select the cassette which will dispense coupons on a random basis.

ERROR CONDITIONS:

There are no error conditions directly associated with this function.



9700-SERIES

9705-SERIES

9710-SERIES

9750-SERIES

ENABLE/DISABLE COUPON AWARDS**FACTORY DEFAULT: DISABLED****ACCESS INSTRUCTIONS:**

1. Select TERMINAL CONFIGURATION from the MANAGEMENT FUNCTIONS menu.
2. Select RANDOM/LEVEL PRIZE COUPONS from the TERMINAL CONFIGURATION menu.
3. Select DISPENSED COUPONS.
4. Select the ENABLE/DISABLE COUPON AWARDS option.

DESCRIPTION:

This function provides access to a menu that allows the operator to ENABLE or DISABLE all dispensed coupon awards. If ENABLED, eligible transactions will be checked for award. If DISABLED, no coupons will be issued.

ERROR CONDITIONS:

There are no error conditions directly associated with this function.



9700-SERIES

9705-SERIES

9710-SERIES

9750-SERIES

SET LEVEL PRIZE AMOUNT**FACTORY DEFAULT: '\$0.00'****ACCESS INSTRUCTIONS:**

1. Select TERMINAL CONFIGURATION from the MANAGEMENT FUNCTIONS menu.
2. Select RANDOM/LEVEL PRIZE COUPONS from the TERMINAL CONFIGURATION menu.
3. Select DISPENSED COUPONS.
4. Select the SET LEVEL PRIZE AMOUNT option.

DESCRIPTION:

This function sets the threshold level at which the level prize coupon will be dispensed. Withdrawing an amount equal to or greater than the value set here will dispense the level prize coupon.

To enter a new value, press the CHANGE button, enter a new value, then press <OK>.

NOTE: If the level coupon is awarded, the random coupon parameter will not be tested for award.

ERROR CONDITIONS:

There are no error conditions directly associated with this function.

LEVEL PRIZE COUPON THRESHOLD

\$.00

ENTER NEW LEVEL. THEN PRESS OK

CHANGE

EXIT

9700-SERIES

9705-SERIES

9710-SERIES

9750-SERIES

SET RANDOM WINNING %**FACTORY DEFAULT:** '0%'**ACCESS INSTRUCTIONS:**

1. Select TERMINAL CONFIGURATION from the MANAGEMENT FUNCTIONS menu.
2. Select RANDOM/LEVEL PRIZE COUPONS from the TERMINAL CONFIGURATION menu.
3. Select DISPENSED COUPONS.
3. Select the SET RANDOM WINNING % option.

DESCRIPTION:

This function sets the frequency at which the random prize coupons will be dispensed. The random coupon is won by a random number of transactions of any type. The winning percentage can be set from 0 to 100%. For example, if the winning percentage is set to 10%, then 1 out of every 10 transactions will be awarded a prize.

To enter a value, press the CHANGE option, enter a new random percentage, then press <OK>.

ERROR CONDITIONS:

There are no error conditions directly associated with this function.



9700-SERIES

9705-SERIES

9710-SERIES

9750-SERIES

CHANGE MESSAGES**FACTORY DEFAULT: N/A****ACCESS INSTRUCTIONS:**

1. Select TERMINAL CONFIGURATION from the MANAGEMENT FUNCTIONS menu.
2. Select CHANGE MESSAGES.

DESCRIPTION:

The CHANGE MESSAGES option of the TERMINAL CONFIGURATION menu allows information for the following screens to be changed by the terminal operator or a service technician:

1. MARKETING MESSAGE
2. SURCHARGE MESSAGES
3. WELCOME MESSAGE
4. SURCHARGE OWNER
5. EXIT MESSAGE
6. STORE MESSAGE
7. TERMINAL OWNER

ERROR CONDITIONS:

There are no error conditions directly associated with this function



9700-SERIES 9705-SERIES 9710-SERIES 9750-SERIES

MARKETING MESSAGE

FACTORY DEFAULT: NONE

ACCESS INSTRUCTIONS:

1. Select TERMINAL CONFIGURATION from the MANAGEMENT FUNCTIONS menu.
2. Select CHANGE MESSAGES.
3. Select MARKETING MESSAGE.

DESCRIPTION:

The MARKETING MESSAGE function allows you to compose a message that will appear on any printed products that include the store message (e.g. customer receipts, day closes, coupons, etc.. The message can be up to four lines long. Enter letters, numbers and punctuation as described in the following paragraphs.

The keys along either side of the display are used with the numeric keys on the main keypad to permit entry of alphanumeric characters. The keys on the left side of the display are designated <F1> through <F4>. The keys on the right side of the display are <F6> through <F8>. The <F1> key centers the text on the line where the cursor appears. The <F2> key erases all text in the current message. <F3> clears the text on the current line.

The <F4> Key is used similarly to a CAPS LOCK key on a computer keyboard. Pressing the <F4> key toggles between uppercase and lowercase. To enter an alphabetic or punctuation character, one of the <F6> through <F8> keys must be pressed, followed by one of the numeric keys. The resultant character will be as indicated in the table. Press the <OK> key to save the changes made. If you make a mistake and want to start over, press the CANCEL key to discard any changes made to that point.

ERROR CONDITIONS:

There are no error conditions directly associated with this function.

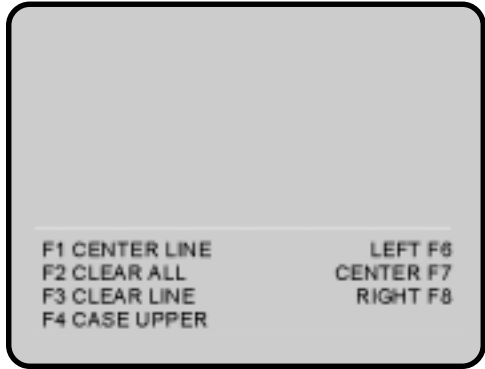

KEY	1	2	3	4	5	6	7	8	9	0
F4 UPPER
No Shift	1	2	3	4	5	6	7	8	9	0
F6 Left	Q	A	D	G	J	M	P	T	W	,
F7 Center	Z	B	E	H	K	N	R	U	X	.
F8 Right	Sp	C	F	I	L	O	S	V	Y	-
F4 LOWER										
No Shift	!	@	#	\$	%	^	&	*	()
F6 Left	q	a	d	g	j	m	p	t	w	'
F7 Center	z	b	c	h	k	n	r	u	x	+
F8 Right	&	c	f	i	l	o	s	v	y	=

9700-SERIES	9705-SERIES	9710-SERIES	9750-SERIES
-------------	-------------	-------------	-------------

SURCHARGE MESSAGES

FACTORY DEFAULT: 'STANDARD'

ACCESS INSTRUCTIONS:

1. Select TERMINAL CONFIGURATION from the MANAGEMENT FUNCTIONS menu.
2. Select CHANGE MESSAGES.
3. Select SURCHARGE MESSAGES

DESCRIPTION:

This function is used to select the surcharge message that will be displayed to the customer. Press the button next to the desired message to select it. Message options STANDARD, A, B and C are accessed from the first SURCHARGE OPTION SCREEN. The MORE option leads to a second screen containing message options D, E, F, G, and H.

ERROR CONDITIONS:

There are no error conditions directly associated with this function.

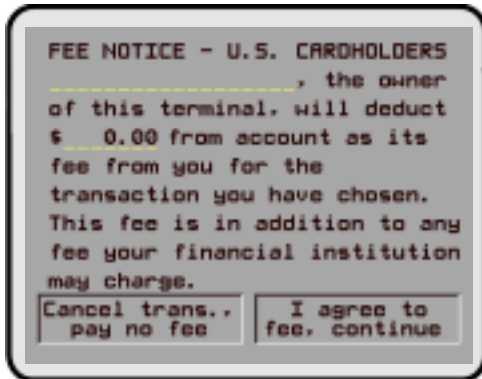

STANDARD

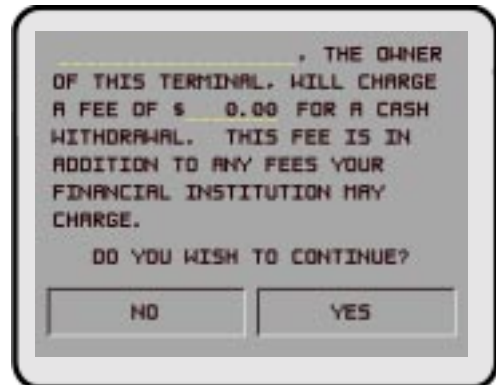

CUSTOM-A

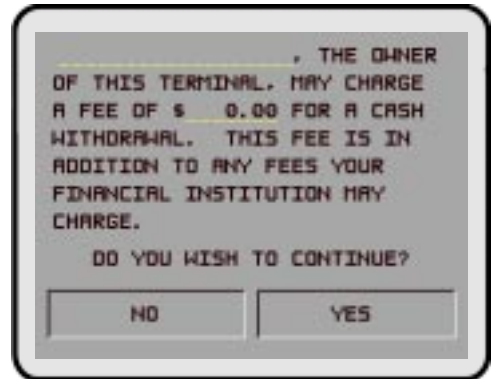

CUSTOM-B

_____, THE OWNER
OF THIS TERMINAL, WILL DEDUCT
\$ ____ 0.00 FROM YOUR ACCOUNT AS
ITS FEE FROM YOU FOR THE
TRANSACTION YOU HAVE CHOSEN.
THIS FEE IS IN ADDITION TO ANY
FEE YOUR FINANCIAL INSTITUTION
MAY CHARGE.

DO YOU WISH TO CONTINUE?

NO, CANCEL YES, I AGREE
PAY NO FEE CONTINUE

CUSTOM-C

_____, THE
OPERATOR OF THIS TERMINAL,
WILL CHARGE A FEE OF
\$ _____ FOR A WITHDRAWAL
PERFORMED BY A US CARD HOLDER
THIS FEE IS IN ADDITION TO ANY
FEES YOUR INSTITUTION MAY
CHARGE.

CANCEL WITH CONTINUE
NO FEE WITH FEE

CUSTOM-F

FEE NOTICE

In addition to any
institutional fees you may be
charged by your bank, the
owner of this terminal
_____ has
assessed a \$ ____ 0.00 fee to
all US cardholders per cash
withdrawal.

NO YES

CUSTOM-D

_____, THE
OPERATOR OF THIS TERMINAL,
WILL CHARGE A FEE OF
\$ _____ OR % _____ OF THE
TRANSACTION AMOUNT WHICHEVER
IS LESSER FOR A WITHDRAWAL
THIS FEE IS IN ADDITION TO ANY
FEES YOUR INSTITUTION MAY
CHARGE

CANCEL WITH CONTINUE
NO FEE WITH FEE

CUSTOM-G

_____, THE
OPERATOR OF THIS TERMINAL,
WILL CHARGE A FEE OF
\$ _____ FOR A WITHDRAWAL
THIS FEE IS IN ADDITION TO ANY
FEES YOUR INSTITUTION MAY
CHARGE.

CANCEL WITH CONTINUE
NO FEE WITH FEE

CUSTOM-E

_____, THE
OPERATOR OF THIS TERMINAL,
WILL CHARGE A FEE OF
\$ _____ OR % _____ OF THE
TRANSACTION AMOUNT WHICHEVER
IS LESSER FOR A WITHDRAWAL
PERFORMED BY A US CARD HOLDER
THIS FEE IS IN ADDITION TO ANY
FEES YOUR INSTITUTION MAY
CHARGE

CANCEL WITH CONTINUE
NO FEE WITH FEE

CUSTOM-H

9700-SERIES 9705-SERIES 9710-SERIES 9750-SERIES

WELCOME MESSAGE

FACTORY DEFAULT: 'WELCOME TO MINIATM'

ACCESS INSTRUCTIONS:

1. Select TERMINAL CONFIGURATION from the MANAGEMENT FUNCTIONS menu.
2. Select CHANGE MESSAGES.
3. Select Welcome Message.

DESCRIPTION:

The Welcome Message consists of three lines of text that are printed at the top of the customer welcome screen. Enter letters, numbers and punctuation as described in the following paragraphs.

The keys along either side of the display are used with the numeric keys on the main keypad to permit entry of alphanumeric characters. The keys on the left side of the display are designated <F1> through <F4>. The keys on the right side of the display are <F6> through <F8>. The <F1> key centers the text on the line where the cursor appears. The <F2> key erases all text in the current message. <F3> clears the text on the current line.

The <F4> Key is used similarly to a CAPS LOCK key on a computer keyboard. Pressing the <F4> key toggles between uppercase and lowercase. To enter an alphabetic or punctuation character, one of the <F6> through <F8> keys must be pressed, followed by one of the numeric keys. The resultant character will be as indicated in the table. Press the <OK> key to save the changes made. If you make a mistake and want to start over, press the CANCEL key to discard any changes made to that point.

ERROR CONDITIONS:

There are no error conditions directly associated with this function.

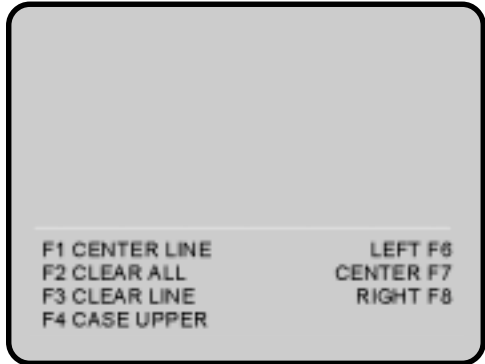

KEY	1	2	3	4	5	6	7	8	9	0
F4 UPPER
No Shift	1	2	3	4	5	6	7	8	9	0
F6 Left	Q	A	D	G	J	M	P	T	W	,
F7 Center	Z	B	E	H	K	N	R	U	X	.
F8 Right	Sp	C	F	I	L	O	S	V	Y	-
F4 LOWER										
No Shift	!	@	#	\$	%	^	&	*	()
F6 Left	q	a	d	g	j	m	p	t	w	'
F7 Center	z	b	c	h	k	n	r	u	x	+
F8 Right	&	c	f	i	l	o	s	v	y	=

9700-SERIES

9705-SERIES

9710-SERIES

9750-SERIES

SURCHARGE OWNER**FACTORY DEFAULT: NONE****ACCESS INSTRUCTIONS:**

1. Select TERMINAL CONFIGURATION from the MANAGEMENT FUNCTIONS menu.
2. Select CHANGE MESSAGES.
3. Select SURCHARGE OWNER.

DESCRIPTION:

The name of the SURCHARGE OWNER is stored in the terminal and printed on the Receipt Printer Test Report. The name of the SURCHARGE OWNER is entered directly into the terminal.

To enter a digit 0-9, simply press the key that has that digit. To enter a letter, first press the <CTRL> key, then press the key that has the letter you want on it. The first press of the key will display the first character above the number. Subsequent presses will display the characters in sequence. When the character you want is displayed, press the <RIGHT ARROW> key to 'lock in' the letter. If your next character is a letter, you must press the <CTRL> key again.

The name can be up to 18 characters long.

ERROR CONDITIONS:

There are no error conditions directly associated with this function



ENTER OWNER'S NAME
THEN PRESS OK

9700-SERIES 9705-SERIES 9710-SERIES 9750-SERIES

EXIT MESSAGE

FACTORY DEFAULT: 'THANKS FOR USING MINIATM'

ACCESS INSTRUCTIONS:

1. Select TERMINAL CONFIGURATION from the MANAGEMENT FUNCTIONS menu.
2. Select CHANGE MESSAGES.
3. Select EXIT MESSAGE.

DESCRIPTION:

The Exit Message consists of three lines of text that are printed on the terminal display at the conclusion of a transaction. Enter letters, numbers and punctuation as described in the following paragraphs.

The keys along either side of the display are used with the numeric keys on the main keypad to permit entry of alphanumeric characters. The keys on the left side of the display are designated <F1> through <F4>. The keys on the right side of the display are <F6> through <F8>. The <F1> key centers the text on the line where the cursor appears. The <F2> key erases all text in the current message. <F3> clears the text on the current line.

The <F4> Key is used similarly to a CAPS LOCK key on a computer keyboard. Pressing the <F4> key toggles between uppercase and lowercase. To enter an alphabetic or punctuation character, one of the <F6> through <F8> keys must be pressed, followed by one of the numeric keys. The resultant character will be as indicated in the table. Press the <OK> key to save the changes made. If you make a mistake and want to start over, press the CANCEL key to discard any changes made to that point.

ERROR CONDITIONS:

There are no error conditions directly associated with this function.

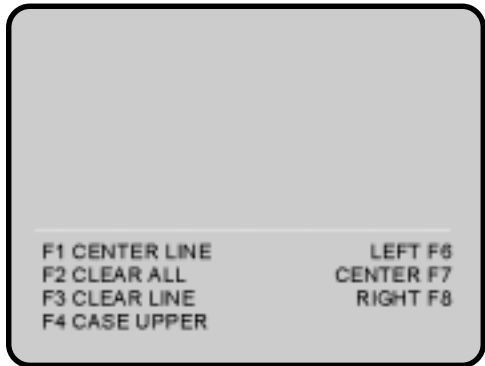

KEY	1	2	3	4	5	6	7	8	9	0
F4 UPPER
No Shift	1	2	3	4	5	6	7	8	9	0
F6 Left	Q	A	D	G	J	M	P	T	W	,
F7 Center	Z	B	E	H	K	N	R	U	X	.
F8 Right	Sp	C	F	I	L	O	S	V	Y	-
F4 LOWER										
No Shift	!	@	#	\$	%	^	&	*	()
F6 Left	q	a	d	g	j	m	p	t	w	'
F7 Center	z	b	c	h	k	n	r	u	x	+
F8 Right	&	c	f	i	l	o	s	v	y	=

9700-SERIES 9705-SERIES 9710-SERIES 9750-SERIES

STORE MESSAGE

FACTORY DEFAULT: SEE NOTE

1. Select TERMINAL CONFIGURATION from the MANAGEMENT FUNCTIONS menu.
2. Select CHANGE MESSAGES.
3. Select STORE MESSAGE.

ACCESS INSTRUCTIONS:

DESCRIPTION:

The STORE MESSAGE consists of four lines of text that are printed on the customer receipt. Enter letters, numbers and punctuation as described in the following paragraphs.

The keys along either side of the display are used with the numeric keys on the main keypad to permit entry of alphanumeric characters. The keys on the left side of the display are designated <F1> through <F4>. The keys on the right side of the display are <F6> through <F8>. The <F1> key centers the text on the line where the cursor appears. The <F2> key erases all text in the current message. <F3> clears the text on the current line.

The <F4> Key is used similarly to a CAPS LOCK key on a computer keyboard. Pressing the <F4> key toggles between uppercase and lowercase. To enter an alphabetic or punctuation character, one of the <F6> through <F8> keys must be pressed, followed by one of the numeric keys. The resultant character will be as indicated in the table. Press the <OK> key to save the changes made. If you make a mistake and want to start over, press the CANCEL key to discard any changes made to that point.

NOTE: ***THIS IS LINE (1-4) OF THE STORE MESSAGE***

ERROR CONDITIONS:

There are no errors directly associated with this function.

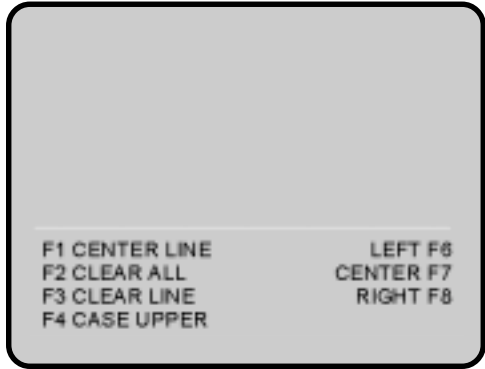

KEY	1	2	3	4	5	6	7	8	9	0
F4 UPPER
No Shift	1	2	3	4	5	6	7	8	9	0
F6 Left	Q	A	D	G	J	M	P	T	W	,
F7 Center	Z	B	E	H	K	N	R	U	X	.
F8 Right	Sp	C	F	I	L	O	S	V	Y	-
F4 LOWER										
No Shift	!	@	#	\$	%	^	&	*	()
F6 Left	q	a	d	g	j	m	p	t	w	'
F7 Center	z	b	c	h	k	n	r	u	x	+
F8 Right	&	c	f	i	l	o	s	v	y	=

9700-SERIES

9705-SERIES

9710-SERIES

9750-SERIES

TERMINAL OWNER**FACTORY DEFAULT: NONE****ACCESS INSTRUCTIONS:**

1. Select TERMINAL CONFIGURATION from the MANAGEMENT FUNCTIONS menu.
2. Select CHANGE MESSAGES.
3. Select TERMINAL OWNER.

DESCRIPTION:

The name of the TERMINAL OWNER is stored in the terminal and displayed to the customer in the surcharge warning message. The name is entered directly into the terminal.

To enter a digit 0-9, simply press the key that has that digit. To enter a letter, first press the <CTRL> key, then press the key that has the letter you want on it. The first press of the key will display the first character above the number. Subsequent presses will display the characters in sequence. When the character you want is displayed, press the <RIGHT ARROW> key to 'lock in' the letter. If your next character is a letter, you must press the <CTRL> key again.

The name can be up to 18 characters long.

ERROR CONDITIONS:

There are no error conditions directly associated with this function.



ENTER OWNER'S NAME
THEN PRESS OK

9700-SERIES

9705-SERIES

9710-SERIES

9750-SERIES

TERMINAL PARAMETERS**FACTORY DEFAULT:** N/A**ACCESS INSTRUCTIONS:**

1. Select TERMINAL CONFIGURATION from the MANAGEMENT FUNCTIONS menu.
2. Select SET TERMINAL PARAMETERS.

DESCRIPTION:

Selecting SET TERMINAL PARAMETERS from the TERMINAL CONFIGURATION menu allows the following Cash Dispenser operating parameters to be viewed or changed:

1. SET TERMINAL #
2. RESET SEQ #
3. SURCHARGE MODE
4. CASSETTE SETUP
5. KEY MANAGEMENT
6. TELEPHONE
7. MORE

ERROR CONDITIONS:

There are no error conditions directly associated with this function.



9700-SERIES

9705-SERIES

9710-SERIES

9750-SERIES

SET TERMINAL #**FACTORY DEFAULT: NONE****ACCESS INSTRUCTIONS:**

1. Select TERMINAL CONFIGURATION from the MANAGEMENT FUNCTIONS menu.
2. Select SET TERMINAL PARAMETERS.
3. Choose the SET TERMINAL # option.

DESCRIPTION:

The TERMINAL # is a unique string of characters provided by your processor to identify the Cash Dispenser when a transaction is taking place. It can contain numbers and letters.

This parameter **MUST** be set before the Cash Dispenser can go on-line AND before the communications key can be downloaded.

When this function is selected, the current TERMINAL # is displayed. If it is to be changed, select CHANGE.

To enter a digit 0-9, press the key that has that digit. To enter a letter, first press the <CTRL> key, then press the key that has the letter you want on it. The first press of the key will display the first character above the number. Subsequent presses will display the characters in sequence. When the character you want is displayed, press the <RIGHT ARROW> key to 'lock in' the letter. If your next character is a letter, you must press the <CTRL> key again.

When you have entered all of the characters, press the <OK> key.

ERROR CONDITIONS:

The Cash Dispenser will not function on-line without a valid TERMINAL #.



9700-SERIES

9705-SERIES

9710-SERIES

9750-SERIES

RESET SEQ #**FACTORY DEFAULT: N/A****ACCESS INSTRUCTIONS:**

1. Select TERMINAL CONFIGURATION from the MANAGEMENT FUNCTIONS menu.
2. Select SET TERMINAL PARAMETERS.
3. Choose the RESET SEQ # option.

DESCRIPTION:

Select the RESET SEQ. # option from the TERMINAL PARAMETER menu to reset the sequence number that is printed on the journal printout and receipt to '00000000'.

Resetting the SEQUENCE # is an operation that should usually be performed at the request of your processor. Use of this function is not required during normal operation.

ERROR CONDITIONS:

There are no error conditions directly associated with this function.



9700-SERIES

9705-SERIES

9710-SERIES

9750-SERIES

SURCHARGE MODE**FACTORY DEFAULT: N/A****ACCESS INSTRUCTIONS:**

1. Select TERMINAL CONFIGURATION from the MANAGEMENT FUNCTIONS menu.
2. Select SET TERMINAL PARAMETERS.
3. Choose the SURCHARGE MODE option.

DESCRIPTION:

Selecting the SURCHARGE MODE option from the SET TERMINAL PARAMETERS menu allows the terminal operator or service technician to change the following surcharge options:

1. SURCHARGE PERCENT
2. ENABLE/DISABLE SURCHARGE MODE
3. SURCHARGE LOCATION
4. BLOCK ISO'S
5. SURCHARGE AMOUNT

ERROR CONDITIONS:

There are no error conditions directly associated with this function.



9700-SERIES

9705-SERIES

9710-SERIES

9750-SERIES

SURCHARGE PERCENT**FACTORY DEFAULT: N/A****ACCESS INSTRUCTIONS:**

1. Select TERMINAL CONFIGURATION from the MANAGEMENT FUNCTIONS menu.
2. Select SET TERMINAL PARAMETERS.
3. Choose the SURCHARGE MODE option.
4. Select SURCHARGE PERCENT.

DESCRIPTION:

The SURCHARGE PERCENT option on the SURCHARGE MODE screen brings up the PERCENT SETTINGS screen, which enables you to enter a surcharge percentage amount, as well as choose the LESSER or GREATER option that is applicable to the surcharge. Remember that these options must conform to the processor's requirements or other applicable commerce regulations.

To enter a surcharge percent value press the CHANGE PERCENT AMOUNT key. the ENTER NEW AMOUNT AND PRESS OK prompt replaces the CURRENT PERCENT IS: field. Enter the applicable percentage value (from 1 and 99 percent) and press "OK".

If the processor or other authority requires that the surcharge be the lesser of either the surcharge amount or surcharge percentage, select the LESSER option. If the surcharge must be the greater of either the surcharge amount or surcharge percentage, select the GREATER option.

This value is stored in the terminal and will be displayed to the customer on the applicable surcharge message screen.

ERROR CONDITIONS:

If a fixed surcharge amount is to be used (surcharge percent not used) you must ensure the surcharge comparison option is set to GREATER and the surcharge percent is set to zero (0). This will ensure that only the fixed surcharge amount value will be displayed to the customer. Failure to do so can cause an incorrect surcharge value to be reported to the customer.

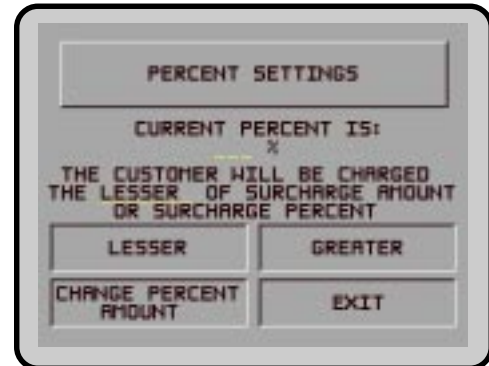

9700-SERIES

9705-SERIES

9710-SERIES

9750-SERIES

ENABLE/DISABLE SURCHARGE**FACTORY DEFAULT: DISABLED****ACCESS INSTRUCTIONS:**

1. Select TERMINAL CONFIGURATION from the MANAGEMENT FUNCTIONS menu.
2. Select SET TERMINAL PARAMETERS.
3. Choose the SURCHARGE MODE option.
4. Select ENABLE or DISABLE, as appropriate.

DESCRIPTION:

Some networks allow a surcharge, or terminal fee, to be imposed on withdrawal transactions. If surcharges are in use on your network, you are required to notify the customer of an additional fee before the transaction is processed. He or she must be given a chance to cancel the transaction. Setting the SURCHARGE MODE to ENABLED will cause a surcharge notification screen to be displayed after the customer's card is inserted into the unit. The customer is given the choice of canceling the transaction at no charge or of continuing.

If your network does not allow surcharges, select the DISABLE option to turn off presentation of the surcharge notification message.

ERROR CONDITIONS:

Be sure to ENABLE this mode if your network allows surcharges.



9700-SERIES

9705-SERIES

9710-SERIES

9750-SERIES

SURCHARGE LOCATION**FACTORY DEFAULT: BEGINNING****ACCESS INSTRUCTIONS:**

1. Select TERMINAL CONFIGURATION from the MANAGEMENT FUNCTIONS menu.
2. Select SET TERMINAL PARAMETERS.
3. Choose the SURCHARGE MODE option.
4. Choose the SURCHARGE LOCATION option.

DESCRIPTION:

The SURCHARGE LOCATION function determines where the terminal user is presented with the surcharge notification message. The surcharge notification message informs the customer about any surcharge that is applicable to the transaction they are completing. When the message appears the terminal user is given the option of accepting the surcharge and continuing the transaction, or canceling the transaction without incurring any charges. The surcharge amount identified in the notification message does not include any additional charges that the bank sponsoring the card may add to the cost of processing a transaction.

Selecting the BEGINNING option displays the applicable surcharge notification message immediately after the terminal user removes the card from the card reader and before their PIN is entered into the terminal.

Selecting the ENDING option displays the surcharge notification message after the terminal user has selected an amount from the FAST CASH menu or entered the amount of the withdrawal and pressed the "<OK>" key to complete the transaction.

ERROR CONDITIONS:

There are no error conditions directly associated with this function.



9700-SERIES

9705-SERIES

9710-SERIES

9750-SERIES

BLOCK ISO'S**FACTORY DEFAULT: NONE****ACCESS INSTRUCTIONS:**

1. Select TERMINAL CONFIGURATION from the MANAGEMENT FUNCTIONS menu.
2. Select SET TERMINAL PARAMETERS.
3. Choose the SURCHARGE MODE option.
4. Choose the BLOCK ISO'S option.

DESCRIPTION:

This function is used to block surcharging and to disable the display of surcharge messages for transactions that use a particular financial institution's ATM or Credit Card. Entering the financial institution's unique ISO (International Standards Organization) Number on this screen enables the function.

The terminal can store up to 100 ISO numbers to block at one time; however, only 5 numbers can be entered using the BLOCK ISO's screen. Additional ISO numbers (up to the 100-number limit) must be downloaded to the terminal using Triton Connect management software.

From 1 to 9 digits may be used. The terminal will compare the card number to all current ISO numbers to the length of each number. For example, three ISO numbers are entered, including '581234', '46', and '3785'. Any card beginning with '46' would match and cause the surcharge notification message to be suppressed (if surcharging were enabled). A card with the starting number '581235' would not match and therefore a surcharge message would appear. With this technique cards from many issuers can be supported. The more digits entered the fewer the number of different cards that will match.

If a card number matches an ISO number to be blocked, the customer will not see the surcharge notification screen. The processor will also be notified of this in the transaction. Most processors support this function. Before enabling this feature, check to make sure your particular processor supports it. Otherwise, your terminal could be in violation of network rules and be sanctioned.



To enter or change an ISO go to the SELECT ISO TO CHANGE screen and perform the following:

1. Press the Screen Key next to the block where the new ISO will be entered or an ISO changed.
2. Enter the ISO number (up to six digits in length).
3. Press the "<OK>" key.

If more than one ISO must be entered repeat steps 1 through 3 until all ISO are entered (up to five ISO numbers may be entered).

ERROR CONDITIONS:

There are no error conditions directly associated with this function.

9700-SERIES

9705-SERIES

9710-SERIES

9750-SERIES

SURCHARGE AMOUNT**FACTORY DEFAULT: '\$0.00'****ACCESS INSTRUCTIONS:**

1. Select TERMINAL CONFIGURATION from the MANAGEMENT FUNCTIONS menu.
2. Select SET TERMINAL PARAMETERS.
3. Choose the SURCHARGE MODE option.
4. Choose the SURCHARGE AMOUNT option.

DESCRIPTION:

The surcharge amount will be entered directly on the SURCHARGE MODE screen. The value you enter here will be displayed to the user in the surcharge notification message that was selected via the SURCHARGE OPTIONS SCREEN function. Press the SURCHARGE AMOUNT menu key. The ENTER NEW AMOUNT AND PRESS 'OK' prompt will appear. Enter a new value. This value will appear in the "AMOUNT = _ _ _ _ _" field that will appear on the SURCHARGE MODE screen. The value will be stored in the terminal and displayed to the customer in the surcharge notification message. See Error Conditions: for additional information on this feature.

ERROR CONDITIONS:

It is important to understand that processor or network rules and/or applicable commerce laws ultimately determine the type and amount of any surcharge that may be assessed against a transaction. The surcharge values that you enter will be displayed to the customer and MUST match the actual surcharge rates established by your processor or other applicable regulatory agencies!

Manually changing the SURCHARGE AMOUNT to a lower or higher amount does not automatically change the surcharge collected by the processor for a transaction. It will only change the surcharge amount displayed during the surcharge-warning message when it is shown to the customer and not the actual fee collected for the transaction.

ENTER NEW AMOUNT AND PRESS 'OK'
 SURCHARGE MODE: **AMOUNT**
 AMOUNT = \$ 0.00

SURCHARGE
PERCENT

ENABLE

BLOCK ISO'S

DISABLE

SURCHARGE
AMOUNTSURCHARGE
LOCATION

EXIT

9700-SERIES	9705-SERIES	9710-SERIES	9750-SERIES
-------------	-------------	-------------	-------------

CASSETTE SETUP

FACTORY DEFAULT: N/A

ACCESS INSTRUCTIONS:

1. Select TERMINAL CONFIGURATION from the MANAGEMENT FUNCTIONS menu.
2. Select SET TERMINAL PARAMETERS.
3. Select CASSETTE SETUP.

DESCRIPTION:

Selecting CASSETTE SETUP at the TERMINAL PARAMETERS menu allows the terminal operator to view and change the following parameters:

9700-SERIES	9705-SERIES	9710-SERIES	9750-SERIES
-------------	-------------	-------------	-------------

1. LOW CURRENCY
2. INTERNATIONAL CURRENCY
3. MAXIMUM AMOUNT
4. MULTIPLE AMOUNT
5. EXTENDED AMOUNT
6. FAST CASH AMOUNT

9700-SERIES	9705-SERIES	9710-SERIES	9750-SERIES
-------------	-------------	-------------	-------------

1. RELEARN BILL THICKNESS
2. INTERNATIONAL CURRENCY
3. MAXIMUM AMOUNT
4. MAX. NON-CASH
5. EXTENDED AMOUNT
6. CASSETTE PARAMETERS
7. FAST CASH AMOUNT

ERROR CONDITIONS:

There are no errors directly associated with the WITHDRAWAL AMOUNTS function.



9700, 9705 and 9710-Series Cash Dispensers



9750-Series Cash Dispensers

9700-SERIES

9705-SERIES

9710-SERIES

9750-SERIES

RELEARN BILL THICKNESS**FACTORY DEFAULT: N/A****ACCESS INSTRUCTIONS:**

1. Select TERMINAL CONFIGURATION from the MANAGEMENT FUNCTIONS menu.
2. Select SET TERMINAL PARAMETERS.
3. Select CASSETTE SETUP.
4. Choose the RELEARN BILL THICKNESS option.

DESCRIPTION:

The first time the dispenser is set up, or if a new Note Cassette is installed, the mechanism will automatically enter a learning mode, during which it will learn the thickness of the currency or other media. During this process the unit will dispense and reject as many as 7-15 notes. For multiple cassettes the number of test rejects could almost fill the single-note compartment of the Reject Cassette. In such cases, it is recommended that you remove any rejected notes from the unit before placing the Cash Dispenser back into service.

In some instances (excessive number of rejects during normal operation, for example) it may be necessary to manually initiate this process. The RELEARN BILL THICKNESS function enables you to force the dispenser to enter the learning mode. Note that the operation affects ALL cassettes in the dispenser! The following screens will be displayed as a result of a successful operation:

ERROR CONDITIONS:

There are no errors directly associated with this function.

**** CAUTION ****

This function will cause the current bill thickness for all cassettes to be lost. Please ensure that you are familiar with this setting before continuing.

CONTINUE

EXIT
(NO CHANGES)PERFORMING
REQUESTED TASK

PLEASE WAIT

REQUEST COMPLETE

BILL SIZES WILL BE RELEARNED
ON NEXT ATTEMPTED DISPENSE OR
TEST DISPENSE. PRESS ANY KEY

9700-SERIES

9705-SERIES

9710-SERIES

9750-SERIES

LOW CURRENCY**FACTORY DEFAULT: ENABLED****ACCESS INSTRUCTIONS:**

1. Select TERMINAL CONFIGURATION from the MANAGEMENT FUNCTIONS menu.
2. Select SET TERMINAL PARAMETERS.
3. Select CASSETTE SETUP.
4. Choose the LOW CURRENCY option.

DESCRIPTION:

This function is used to enable or disable low currency checking on the dispenser mechanism. If LOW CURRENCY CHECKING is ENABLED, the Cash Dispenser will go out of service (it will display an ERROR 182) when the cash cassette gets down to approximately 60 notes. Enabling LOW CURRENCY CHECKING will prevent the need for reversals because there will never be a partial dispense.

If LOW CURRENCY CHECKING is DISABLED, the Cash Dispenser will not go out of service until the cassette is completely empty. This may result in the need to reverse the last withdrawal due to a partial dispense occurring. In the event of a partial dispense, or no dispense, the terminal will automatically inform the Processor and the customer's account will be correctly credited. The record of the successful reversal will be recorded in the journal record.

ERROR CONDITIONS:

If the cassette runs out of currency during a dispense, the terminal will generate another call to the processor to reverse the amount not dispensed. Do not reset or turn off the terminal during this call. Doing so will cause the reversal to fail and result in an out of balance condition.

**LOW CURRENCY CONDITIONS IN
MODEL 9700-SERIES CASH
DISPENSERS**

When the cassette runs out of money during a dispense operation an Error Code 33 (feed failure) will be displayed and the terminal will go out of service.

If the error condition is reset with less than about 1/2" to 3/4" of bills in the cassette an error code 182 will be displayed (even with LOW CURRENCY CHECKING disabled).

To avoid this the Cash Dispenser must be reset with the cassette out of the dispenser, or more than 60 bills must be loaded into the cassette.

9700-SERIES

9705-SERIES

9710-SERIES

9750-SERIES

INTERNATIONAL CURRENCY**FACTORY DEFAULT: COUNTRY-SPECIFIC****ACCESS INSTRUCTIONS:**

1. Select TERMINAL CONFIGURATION from the MANAGEMENT FUNCTIONS menu.
2. Select SET TERMINAL PARAMETERS.
3. Select CASSETTE SETUP.
4. Choose the INTERNATIONAL CURRENCY option.

DESCRIPTION:

This feature will allow operator personnel to select one of nine possible monetary symbols (C, ¢, \$, f, L, Pt., £, Q, ¥) that describe the type of currency that will be dispensed by the Cash Dispenser. The default symbol can be viewed and changed through the terminals' Management Functions.

Monetary symbols for use with following currencies are supported by the Cash Dispenser:

1. C - The symbol for the Colon (Costa Rica)
2. ¢ - The symbol for the Colon (El Salvador)
3. \$ - The symbol of the Dollar and Peso
4. f - The symbol for the Franc
5. L - The symbol for the Lempira
6. Pt - The symbol for the Peseta
7. £ - The symbol for the Pound
8. Q - The symbol for the Quetzal
9. ¥ - The symbol for the Yen

When the INTERNATIONAL CURRENCY menu is displayed, press the screen key next to the CHANGE SYMBOL option until the desired currency symbol is displayed. Press EXIT to make that symbol the default symbol displayed on the terminal.

ERROR CONDITIONS:

There are no error conditions directly associated with this function.



9700-SERIES

9705-SERIES

9710-SERIES

9750-SERIES

MAXIMUM AMOUNT**FACTORY DEFAULT: '\$500.00'****ACCESS INSTRUCTIONS:**

1. Select TERMINAL CONFIGURATION from the MANAGEMENT FUNCTIONS menu.
2. Select SET TERMINAL PARAMETERS.
3. Select CASSETTE SETUP.
4. Choose the MAXIMUM AMOUNT option.

DESCRIPTION:

The maximum cash withdrawal limit must be set in the Cash Dispenser before any transactions can be completed. This number is the largest dollar amount allowed for a withdrawal transaction. It can be set from 1 to 999999 in increments of 1 and it must be an even multiple of the denomination that is in the cassette. Factory default is set to \$500.00. The value is dollar amount only; no cents are allowed.

Whenever a withdrawal amount is entered or selected (via the FAST CASH option), the amount entered or selected is compared to this amount. If the entry is larger, an error message warns the user and displays the maximum allowable amount.

This amount DOES NOT override any maximum set by a network. The transaction will be sent to the network if the amount entered or selected is less than or equal to the maximum. The network must still approve the amount.

ERROR CONDITIONS:

The MAXIMUM AMOUNT cannot be more than 50 times the MULTIPLE AMOUNT.

MAXIMUM WITHDRAW LIMIT

\$.00

ENTER NEW AMOUNT & PRESS 'OK'

CHANGE

EXIT

9700-SERIES

9705-SERIES

9710-SERIES

9750-SERIES

MULTIPLE AMOUNT**FACTORY DEFAULT: '\$0.00'****ACCESS INSTRUCTIONS:**

1. Select TERMINAL CONFIGURATION from the MANAGEMENT FUNCTIONS menu.
2. Select SET TERMINAL PARAMETERS.
3. Select CASSETTE SETUP.
4. Choose the MULTIPLE AMOUNT option.

DESCRIPTION:

The MULTIPLE AMOUNT must be set in the Cash Dispenser before any transactions can be processed. This number is the denomination of the currency installed in the currency cassette. It can be set to any value, as long as this value is no less than 1/50th of the MAXIMUM AMOUNT. Typical values might be 10, 20, 50, or 100.

Whenever a withdrawal transaction is performed, the amount entered or selected is compared to the MULTIPLE AMOUNT. If the entry is not an even multiple of this amount, an error warns the terminal user and displays the current multiple amount.

ERROR CONDITIONS:

If the MULTIPLE AMOUNT is not set correctly, the terminal will respond by going into Configuration Error 186, BILL SIZE NOT CONFIGURED CORRECTLY. To correct the error condition enter the management functions and configure the bill size (MULTIPLE AMOUNT) to the size of the bill in the cassette.



9700-SERIES

9705-SERIES

9710-SERIES

9750-SERIES

MAX NON-CASH**FACTORY DEFAULT: '\$500.00'****ACCESS INSTRUCTIONS:**

1. Select TERMINAL CONFIGURATION from the MANAGEMENT FUNCTIONS menu.
2. Select SET TERMINAL PARAMETERS.
3. Select CASSETTE SETUP.
4. Choose the MAX NON-CASH.

DESCRIPTION:

The maximum non-cash purchase limit must be set in the Cash Dispenser before any purchases of non-cash items can be completed. This number is the largest dollar amount allowed for the purchase of a non-cash item from the Cash Dispenser. It can be set from 1 to 999999 in increments of 1 and it must be an even multiple of the value of single unit of the non-cash item that is in the cassette. Factory default is set to \$500.00. The value is a dollar amount only; no cents are allowed.

ERROR CONDITIONS:

There are no error conditions directly associated with this function.

MAXIMUM WITHDRAW LIMIT

\$.00

ENTER NEW AMOUNT & PRESS 'OK'

CHANGE

EXIT

9700-SERIES

9705-SERIES

9710-SERIES

9750-SERIES

EXTENDED AMOUNT**FACTORY DEFAULT: DISABLED****ACCESS INSTRUCTIONS:**

1. Select TERMINAL CONFIGURATION from the MANAGEMENT FUNCTIONS menu.
2. Select SET TERMINAL PARAMETERS.
3. Select CASSETTE SETUP.
4. Choose the EXTENDED AMOUNT option.

DESCRIPTION:

The standard length of a currency amount entry field is 8 digits. In some applications this length is insufficient to allow the entry of the full range of customer transaction values in the local currency type. This feature allows the selection of 12-digit currency fields for those applications that require it.

To activate 12-digit field lengths, select the ENABLE option. To return to 8-digit field lengths, choose the DISABLE option.

ERROR CONDITIONS:

There are no error conditions directly associated with this function.

ENABLING THE EXTENDED AMOUNT
WILL INCREASE THE TRANSFER
FIELD FROM 8 TO 12 DIGITS.

WARNING
ONLY USE THE EXTENDED AMOUNT
IF YOUR PROCESSOR CAN ACCEPT
THIS PROTOCOL.

EXTENDED AMOUNTS ARE: DISABLED

9700-SERIES

9705-SERIES

9710-SERIES

9750-SERIES

CASSETTE PARAMETERS**FACTORY DEFAULT:** N/A**ACCESS INSTRUCTIONS:**

1. Select TERMINAL CONFIGURATION from the MANAGEMENT FUNCTIONS menu.
2. Select SET TERMINAL PARAMETERS.
3. Select CASSETTE SETUP.
4. Select CASSETTE PARAMETERS.

DESCRIPTION:

The CASSETTE PARAMETERS option is used to perform cassette-specific configuration and setup operations. When the CASSETTE PARAMETERS option is selected, a cassette selection screen (see the description of the CASSETTE option for more information) is presented which allows the operator to select the specific cassette which will be the focus of the subsequent setup or configuration operations. The cassette selection screen is followed by the cassette parameters options screen. The CASSETTE PARAMETERS option screen provides access to the following functions:

1. SET BILL DIMENSION
2. VALUE
3. TYPE
4. SERVICE
5. CURRENCY DATA
6. CASSETTE
7. DESCRIPTION

ERROR CONDITIONS:

There are no error conditions directly associated with this function.



9700-SERIES

9705-SERIES

9710-SERIES

9750-SERIES

SET BILL DIMENSION**FACTORY DEFAULT: COUNTRY-SPECIFIC****ACCESS INSTRUCTIONS:**

1. Select TERMINAL CONFIGURATION from the MANAGEMENT FUNCTIONS menu.
2. Select SET TERMINAL PARAMETERS.
3. Select CASSETTE SETUP.
4. Choose the CASSETTE PARAMETERS option.
5. Select a cassette (A, B, C, or D).
6. Choose SET BILL DIMENSION.

DESCRIPTION:

This function enables you to enter the WIDTH and LENGTH measurements of the item in the specified cassette. The information you enter will be stored in the cassette, so it is important to ensure that the specified cassette is present in the mechanism during this operation. If the operation fails, an error message will be displayed.

ERROR CONDITIONS:

There are no error conditions directly associated with this function.



9700-SERIES

9705-SERIES

9710-SERIES

9750-SERIES

VALUE**FACTORY DEFAULT: '\$0.00'****ACCESS INSTRUCTIONS:**

1. Select TERMINAL CONFIGURATION from the MANAGEMENT FUNCTIONS menu.
2. Select SET TERMINAL PARAMETERS.
3. Select CASSETTE SETUP.
4. Choose the CASSETTE PARAMETERS option.
5. Choose a cassette (A, B, C, or D).
6. Select the VALUE option.

DESCRIPTION:

The VALUE function allows the operator to set the value of a cash or non-cash item in a particular cassette. For cash, VALUE must be the denomination of the currency currently inside that particular cassette and must be a whole dollar amount without cents. For non-cash, VALUE is the face value of that particular item within the cassette and can be any value. The default setting for VALUE is \$0.00

ERROR CONDITIONS:

An error code will occur when a non-whole dollar amount is applied to a cash cassette. Example, setting the cassette to CASH and entering the VALUE as \$5.15 will cause the terminal to indicate Error# 186 Bill Size Not Configured.

MULTIPLE AMOUNT

\$.00

ENTER NEW AMOUNT & PRESS 'OK'

CHANGE

EXIT

9700-SERIES

9705-SERIES

9710-SERIES

9750-SERIES

TYPE**FACTORY DEFAULT: CASH****ACCESS INSTRUCTIONS:**

1. Select TERMINAL CONFIGURATION from the MANAGEMENT FUNCTIONS menu.
2. Select SET TERMINAL PARAMETERS.
3. Select CASSETTE SETUP.
4. Choose the CASSETTE PARAMETERS option.
5. Choose a cassette (A, B, C, or D).
6. Select the TYPE option.

DESCRIPTION:

This function allows the user to set what type of item is currently installed within the cassette. The Type is either CASH or NON-CASH. CASH is any currency such as \$5, \$10, \$20, \$50, etc. NON-CASH is any item other than CASH such as Stamps, Coupons, or Phone Cards.

ERROR CONDITIONS:

There are no error conditions directly associated with this function.

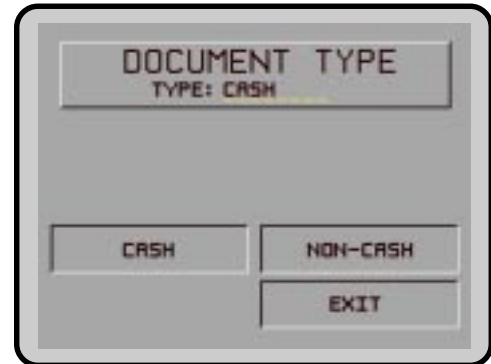

9700-SERIES

9705-SERIES

9710-SERIES

9750-SERIES

SERVICE**FACTORY DEFAULT: IN SERVICE****ACCESS INSTRUCTIONS:**

1. Select TERMINAL CONFIGURATION from the MANAGEMENT FUNCTIONS menu.
2. Select SET TERMINAL PARAMETERS.
3. Select CASSETTE SETUP.
4. Choose the CASSETTE PARAMETERS option.
5. Choose a cassette (A, B, C, or D).
6. Select the SERVICE option.

DESCRIPTION:

This function allows the user to set the desired cassette to either IN SERVICE or OUT OF SERVICE. Placing a cassette IN SERVICE will allow the dispenser to access the item inside the cassette. Placing a cassette OUT OF SERVICE effectively turns the cassette off and does not allow any access to the items in the cassette.

ERROR CONDITIONS:

When a cassette is removed from the Dispenser while AC power is on, the status of that cassette will automatically revert to OUT OF SERVICE. If that cassette is to be used for future transactions it must be put IN SERVICE before it is recognized in the Dispenser.



9700-SERIES

9705-SERIES

9710-SERIES

9750-SERIES

CURRENCY DATA**FACTORY DEFAULT: COUNTRY-SPECIFIC****ACCESS INSTRUCTIONS:**

1. Select TERMINAL CONFIGURATION from the MANAGEMENT FUNCTIONS menu.
2. Select SET TERMINAL PARAMETERS.
3. Select CASSETTE SETUP.
4. Choose the CASSETTE PARAMETERS option.
5. Choose a cassette (A, B, C, or D).
6. Select the CURRENCY DATA option.

DESCRIPTION:

The CURRENCY DATA Function enables you to enter a seven-character string of parameters that describes the currency in a cassette (see Figure above). The parameter string consists of: 1. Currency Code, 2. Value and 3. Variant Code.

CURRENCY CODE. This is a three-character descriptor for the currency type (example: 'USD' represents US Dollars). See the Table on the next page for a listing of supported Currency Codes. To use the Table, find the country of interest in the left-hand column, then move to the right to find the description of the currency type in the second column. Move to the third column to find the specific three-character Currency Code to use for the selected country and currency type.

VALUE. This three-character parameter describes the denomination of the currency in the cassette. The Value is two-part: a two-character base value and a single-character multiplier. The Value '021', for example, consists of a base value of '02' and a multiplier of '1'. The multiplier represents the number of zeros to add to the base value. In this example, add one "zero" to '02' ('02' + '0'), to make '020', which indicates a denomination of twenty ('USD021', for example, represents a twenty US dollar denomination). The value 'USD012' would represent a 100 ('01' + '00') US dollar denomination.

VARIANT. This is a single-character that represents the "version" of the note. The Variant Code should initially be set to "1"; if a new version of the denomination becomes available, contact Triton Systems Technical Support for an updated Variant Code.

USD0211

Please enter in the new currency data in the format XXXYYZ, where
 XXX=3 letter code for currency
 YYY=3 numbers denoting value
 Z=Number representing variant

CHANGE

EXIT

The current values of the above listed data will be displayed near the top of the screen as a string of seven characters. When the CHANGE button is pressed, an input field appears, allowing you to enter new data.

To enter a digit 0-9, simply press the key that has that digit. To enter a letter, first press the <CTRL> key, then press the key that has the letter you want on it. The first press of the key will display the first character above the number. Subsequent presses will display the characters in sequence. When the character you want is displayed, press the <RIGHT ARROW> key to 'lock in' the letter. If your next character is a letter, you must press the <CTRL> key again.

Enter the data appropriate for the type, value, and variant for the currency to be loaded into the cassette, then press the OK button to accept it.

IMPORTANT: After entering of the new currency data, remove and reinstall each cassette in the Cash Dispenser. This will ensure the updated information is successfully stored in the cassette(s). Remove and reinstall all cassettes, even if currency data was changed in only one cassette.

ERROR CONDITIONS:

To ensure accurate note dispensing it is vital that the correct Currency Data for each cassette be entered during the initial setup of the Cash Dispenser! Remember to enter the Currency Data for each cassette before placing that cassette into service, and whenever a new currency type, value, or denomination is used in a cassette.

COUNTRY CODE	CURRENCY TYPE	CURRENCY CODE	COUNTRY CODE	CURRENCY TYPE	CURRENCY CODE
ARGENTINA	ARGENTINE PESO	ARS	EL SALVADOR	EL SALVADOR COLON	SVC
AUSTRALIA	AUSTRALIAN DOLLAR	AUD	FRANCE	FRENCH FRANC	FRF
BOLIVIA	BOLIVIANO	BOB	GERMANY	DEUTSCHE MARK	DEM
BOLIVIA	MVDOL	BOV	GREECE	DRACHMA	GRD
BRAZIL	BRAZILIAN REAL	BRL	GUATEMALA	QUETZAL	GTO
CANADA	CANADIAN DOLLAR	CAD	HONDURAS	LEMPIRA	HNL
CHILE	CHILEAN PESO	CLP	HONG KONG	HONG KONG DOLLAR	HKD
CHILE	UNIDADES DE FORMENTO	CLF	HUNGARY	FORINT	HUF
COLOMBIA	COLOMBIAN PESO	COP	IRELAND	IRISH POUND	IEP
COSTA RICA	COSTA RICAN COLON	CRC	MEXICO	MEXICAN NUEVO PESO	MXN
CYPRUS	CYPRUS PUND	CYP	NEW ZEALAND	NEW ZEALAND DOLLAR	NZD
CZECH REPUBLIC	CZECH KORUNA	CZK	NICARAGUA	CORDOBA ORO	NIO
DOMINICAN REPUBLIC	DOMINICAN PESO	DOP	PUERTO RICO	US DOLLAR	USD
ECUADOR	SUCRE	ECS	SOUTH AFRICA	RAND	ZAR
ECUADOR	UNIDAD DE VALOR CONSTANTE (UVC)	ECV	UNITED KINGDOM	POUND STERLING	GBP
EGYPT	EGYPTIAN POUND	EGP	UNITED STATES	US DOLLAR	USD

9700-SERIES

9705-SERIES

9710-SERIES

9750-SERIES

CASSETTE**FACTORY DEFAULT: N/A****ACCESS INSTRUCTIONS:**

1. Select TERMINAL CONFIGURATION from the MANAGEMENT FUNCTIONS menu.
2. Select SET TERMINAL PARAMETERS.
3. Select CASSETTE SETUP.
4. Choose the CASSETTE PARAMETERS option.
5. Select the CASSETTE option.

DESCRIPTION:

This option provides a convenient way to switch between cassettes when performing cassette-specific operations. Simply select the cassette you wish to work with (A, B, C, or D) and a menu of configuration functions applicable to the selected cassette will be presented.

This option is also used to LOCK or UNLOCK the cassettes in the dispensing mechanism chassis. Note that this function affects all of the cassettes as a group. The LOCK CASSETTES option button will lock all cassettes as a group, while the UNLOCK CASSETTES option will UNLOCK all cassettes as a group. The current lock status of the cassettes is indicated by the label in the lower left part of the display.

You must UNLOCK the cassettes before removing any of them from the mechanism. After re-installing one or more cassettes, LOCK them in place prior to placing the Cash Dispenser back into operation.

ERROR CONDITIONS:

There are no error conditions directly associated with this function.

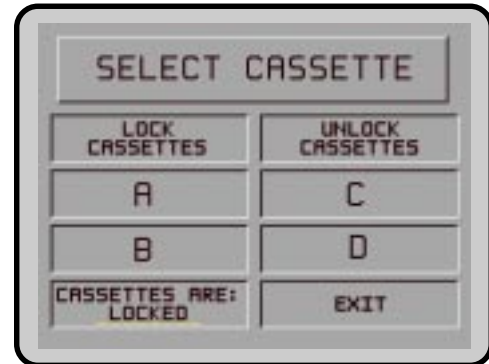

9700-SERIES

9705-SERIES

9710-SERIES

9750-SERIES

DESCRIPTION**FACTORY DEFAULT:** N/A**ACCESS INSTRUCTIONS:**

1. Select TERMINAL CONFIGURATION from the MANAGEMENT FUNCTIONS menu.
2. Select SET TERMINAL PARAMETERS.
3. Select CASSETTE SETUP.
4. Choose the CASSETTE PARAMETERS option.
5. Choose a cassette (A, B, C, or D).
6. Select the DESCRIPTION option.

DESCRIPTION:

The DESCRIPTION function provides access to menus that let the terminal owner enter a brief description of NON-CASH only items in a cassette. There are two menus for entering descriptive information. The PRIMARY DESCRIPTION is used to provide a brief description of the items in the NON-CASH cassettes. Examples of descriptions are PHONE CARDS, COUPONS, STAMPS, etc. The SECONDARY DESCRIPTION provides a location for other information of general interest or information required by law.

See the coverage of the PRIMARY DESCRIPTION and SECONDARY DESCRIPTION functions on the following pages for additional information and procedures for entering the descriptions.

ERROR CONDITIONS:

There are no error conditions directly associated with this function.

SELECT DESCRIPTION FIELD
TO MODIFYPRIMARY
DESCRIPTIONSECONDARY
DESCRIPTION

EXIT

9700-SERIES

9705-SERIES

9710-SERIES

9750-SERIES

PRIMARY DESCRIPTION**FACTORY DEFAULT: NONE****ACCESS INSTRUCTIONS:**

1. Select TERMINAL CONFIGURATION from the MANAGEMENT FUNCTIONS menu.
2. Select SET TERMINAL PARAMETERS.
3. Select CASSETTE SETUP.
4. Choose the CASSETTE PARAMETERS option.
5. Choose a cassette (A, B, C, or D).
6. Select the DESCRIPTION option.
7. Choose the PRIMARY DESCRIPTION option.

DESCRIPTION:

The PRIMARY DESCRIPTION is used to provide a brief description of the items in the NON-CASH cassettes. Examples of descriptions are PHONE CARDS, COUPONS, STAMPS, etc.

To enter a number, press the key that has that number. To enter a letter, first press the CTRL key, then press the key that has the letter you want. The first press of the key will display the first character above the number. Subsequent presses will display the other characters in sequence. When the character you want is displayed, press the <RIGHT ARROW> key 'to lock' in the letter. If the next character is a letter, the CTRL key must again be pressed first. The description of a NON-CASH item may contain up to 28 alphanumeric characters.

ERROR CONDITIONS:

There are no error conditions directly associated with this function

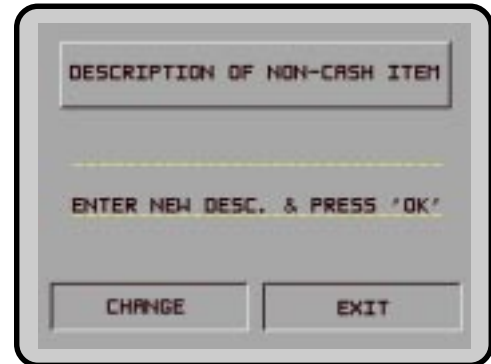

9700-SERIES

9705-SERIES

9710-SERIES

9750-SERIES

SECONDARY DESCRIPTION**FACTORY DEFAULT: 'NONE'****ACCESS INSTRUCTIONS:**

1. Select TERMINAL CONFIGURATION from the MANAGEMENT FUNCTIONS menu.
2. Select SET TERMINAL PARAMETERS.
3. Select CASSETTE SETUP.
4. Choose the CASSETTE PARAMETERS option.
5. Choose a cassette (A, B, C, or D).
6. Select the DESCRIPTION option.
7. Choose the SECONDARY DESCRIPTION option.

DESCRIPTION:

The SECONDARY DESCRIPTION provides a location for other information of general interest or information required by law.

To enter a number, press the key that has that number. To enter a letter, first press the CTRL key, then press the key that has the letter you want. The first press of the key will display the first character above the number. Subsequent presses will display the other characters in sequence. When the character you want is displayed, press the <RIGHT ARROW> key 'to lock' in the letter. If the next character is a letter, the CTRL key must again be pressed first.

The description of a NON-CASH item may contain up to 28 alphanumeric characters.

IS THE SECONDARY DESCRIPTION
OF NON-CASH ITEMS

ENTER NEW DESC. & PRESS 'OK'

CHANGE

EXIT

9700-SERIES

9705-SERIES

9710-SERIES

9750-SERIES

FAST CASH AMOUNT**FACTORY DEFAULT: PROCESSOR-SPECIFIC****ACCESS INSTRUCTIONS:**

1. Select TERMINAL CONFIGURATION from the MANAGEMENT FUNCTIONS menu.
2. Select SET TERMINAL PARAMETERS.
3. Select CASSETTE SETUP.
4. Choose the FAST CASH AMOUNT option.

DESCRIPTION:

During a withdrawal transaction the FAST CASH screen prompts the customer to select the amount of the withdrawal from a list of five convenient amounts. These amounts are entered by the terminal operator using the FAST CASH AMOUNT function. Up to six digits (more with software versions that support extended field lengths) can be entered into any data field accepting a monetary value.

Selecting this function displays the FAST CASH SCREEN AMOUNTS screen. Press the screen key next to the amount to be changed, and it will begin to blink. Enter the new amount (whole dollar amount only), and then press the <OK> key. The value will replace the blinking amount.

The amounts entered must be even multiples of the denomination in the cassette. The amounts do not have to be in any particular order, although typically, they increase in value moving from upper left and down, then upper right and down. DO NOT enter an amount that is larger than the MAXIMUM WITHDRAWAL AMOUNT.

ERROR CONDITIONS:

There are no error conditions directly associated with this function.

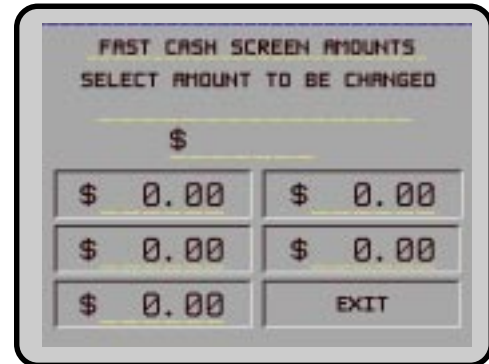

9700-SERIES

9705-SERIES

9710-SERIES

9750-SERIES

KEY MANAGEMENT**FACTORY DEFAULT: N/A****ACCESS INSTRUCTIONS:**

1. Select TERMINAL CONFIGURATION from the MANAGEMENT FUNCTIONS menu.
2. Select SET TERMINAL PARAMETERS.
3. Choose the KEY MANAGEMENT option.

DESCRIPTION:

The KEY MANAGEMENT function provides access to Cash Dispenser functions that control the method of entry for the Master Key and the Comms (Communications) Key. The functions accessed through this menu are listed below:

1. ENTER MAC MASTER KEY
2. ENTER PIN MASTER KEY
3. INJECT MASTER KEYS
4. ENTER MAC WORKING KEY
5. ENTER PIN WORKING KEY
6. DOWNLOAD WORKING KEYS

ERROR CONDITIONS:

IMPORTANT: The MAC MASTER KEY must be entered before the MAC Working key. Likewise, the PIN MASTER KEY must be entered before the PIN Working key.



9700-SERIES	9705-SERIES	9710-SERIES	9750-SERIES
-------------	-------------	-------------	-------------

ENTER MAC MASTER KEY

FACTORY DEFAULT: PROCESSOR-SPECIFIC

ACCESS INSTRUCTIONS:

1. Select TERMINAL CONFIGURATION from the MANAGEMENT FUNCTIONS menu.
2. Select SET TERMINAL PARAMETERS.
3. Select KEY MANAGEMENT.
4. Choose the ENTER MAC MASTER KEY option.

DESCRIPTION:

NOTE: The MAC MASTER KEY feature is applicable only to terminals using Triton Standard ATM software and a Secure Pin Entry Device (SPED) module.

IMPORTANT: The MAC MASTER KEY must be entered before the MAC Working key.

MAC is an acronym for Message Authentication Code. The MAC MASTER KEY is used to protect the MAC WORKING KEY during manual entry or downloading of the working key. The MAC MASTER KEY is a 16-character string, consisting of the digits 0-9 and the letters A-F. Your processor must provide you with the MAC MASTER KEY. If a MAC authentication attempt on a message fails, the message will fail. This is a security precaution.

For security reasons, when entering this key, a '*' is displayed in place of the actual character. Since it is not possible to view the key while it is entered, the key must be entered in twice to make sure it was entered properly.

To enter a digit 0-9, simply press the key that has that digit, and a '*' will appear. To enter the letters A-F, first press the <CTRL> key, then press the key that has the letter you want on it. The first press of the key will display the first character above the number. Subsequent presses will display the characters in sequence. When the character you want is displayed, press the <RIGHT ARROW> key to 'lock in' the letter. If your next character is a letter, you must press the <CTRL> key again. Press the <CHANGE> key to clear the entry and start over. Press the <LEFT ARROW> key to back up and erase a character.



In some versions of ATM software the MAC MASTER KEY consists of TWO 16-character strings: a LEFT KEY BLOCK and a RIGHT KEY BLOCK:



Each block consists of some combination of the digits 0-9 and the Hexadecimal ("Hex") characters A-F. Follow these instructions if your ATM uses LEFT and RIGHT KEY BLOCKS.

Selecting the LEFT KEY BLOCK or RIGHT KEY BLOCK option will display the appropriate key-entry screen, as shown here:



Normally, the MAC MASTER KEY contains only one part. However, some keys may contain multiple parts. If this is the case, separate individuals will hold the parts. If your key has multiple parts you must answer the question "ANOTHER KEY PART?", with a YES until all parts are entered.

The CHECK DIGIT that appears after all parts of the MAC MASTER KEY have been entered is similar to the checksum that is used to verify that the data programmed into a memory device such as an EPROM is correct. The CHECK DIGIT can be verified by doing a RECEIPT PRINTER TEST from the DIAGNOSTICS Menu and comparing the MAC MASTER KEY CHECK DIGIT on the printout to the original receipt printout from the initial terminal setup. If the CHECK DIGIT is different from the original, and the terminal is not operating correctly, the MAC MASTER KEY is corrupt and you should contact your service organization for assistance.

ERROR CONDITIONS:

If the MAC MASTER KEY is not entered correctly, no message traffic can take place, so be sure to enter the key accurately. If your second entry of the key does not match the first entry, you will be warned and allowed to start over with the first entry.

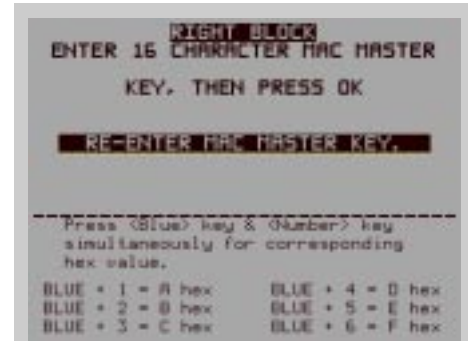

To enter a digit 0-9, simply press the key that has the desired digit, and a '*' will appear. To enter a Hex character (A through F), first press and hold down the <CTRL> key. While holding down the <CTRL> key, press the numbered key (1-6) that corresponds to the character you want to enter, as listed in the table on-screen (1=A, 2=B, 3=C, 4=D, 5=E, 6=F). A '*' character will appear. Release the <CTRL> key. Repeat for each character in the key. Press the <CHANGE> key to clear the entry and start over. Press the <LEFTARROW> key to back up and erase a character.

You must enter the key sequence TWICE for each KEY BLOCK: after the second entry, you will be prompted to enter a second key part. In most instances you will answer NO to this prompt, but in some cases a second sequence of characters may need to be entered (this requirement is processor-specific). requirement is processor-specific).

9700-SERIES 9705-SERIES 9710-SERIES 9750-SERIES

ENTER PIN MASTER KEY

FACTORY DEFAULT: PROCESSOR-SPECIFIC

ACCESS INSTRUCTIONS:

1. Select TERMINAL CONFIGURATION from the MANAGEMENT FUNCTIONS menu.
2. Select SET TERMINAL PARAMETERS.
3. Select KEY MANAGEMENT.
4. Choose the ENTER PIN MASTER KEY option.

DESCRIPTION:

IMPORTANT: The PIN MASTER KEY must be entered before the PIN Working key.

NOTE: The PIN MASTER KEY was referred to as the MASTER KEY in previous versions of ATM software.

The PIN MASTER KEY is used to protect the PIN WORKING KEY during manual entry or downloading of the working key. This key is a 16-character string, consisting of the digits 0-9 and the letters A-F. Your processor must provide you with the PIN MASTER KEY.

For security reasons, when entering this key, a '*' is displayed in place of the actual character. Since it is not possible to view the key while it is entered, the key must be entered in twice to make sure it was entered properly.

To enter a digit 0-9, simply press the key that has that digit, and a '*' will appear. To enter the letters A-F, first press the <CTRL> key, then press the key that has the letter you want on it. The first press of the key will display the first character above the number. Subsequent presses will display the characters in sequence. When the character you want is displayed, press the <RIGHT ARROW> key to 'lock in' the letter. If your next character is a letter, you must press the <CTRL> key again. Press the <CHANGE> key to clear the entry and start over. Press the <LEFT ARROW> key to back up and erase a character.

Normally, the PIN MASTER KEY contains only one part. However, some keys may contain multiple parts. If this is the case, separate individuals will hold the parts. If your key has multiple parts you must answer the question "ANOTHER KEY PART?", with a YES until all parts are entered.



In some versions of ATM software the PIN MASTER KEY consists of TWO 16-character strings: a LEFT KEY BLOCK and a RIGHT KEY BLOCK:



Each block consists of some combination of the digits 0-9 and the Hexadecimal ("Hex") characters A-F. Follow these instructions if your ATM uses LEFT and RIGHT KEY BLOCKS.

Selecting the LEFT KEY BLOCK or RIGHT KEY BLOCK option will display the appropriate key-entry screen, as shown here:



The CHECK DIGIT that appears after all parts of the PIN MASTER KEY have been entered is similar to the checksum that is used to verify that the data programmed into a memory device such as an EPROM is correct. The CHECK DIGIT can be verified by doing a RECEIPT PRINTER TEST from the DIAGNOSTICS Menu and comparing the PIN MASTER KEY CHECK DIGIT on the printout to the original receipt printout from the initial terminal setup. If the CHECK DIGIT is different from the original, and the terminal is not operating correctly, the PIN MASTER KEY is corrupt, and you should contact your service organization for assistance.

ERROR CONDITIONS:

If the PIN MASTER KEY is not entered correctly, no message traffic can take place, so be sure to enter the key accurately. If your second entry of the key does not match the first entry, you will be warned and allowed to start over with the first entry.

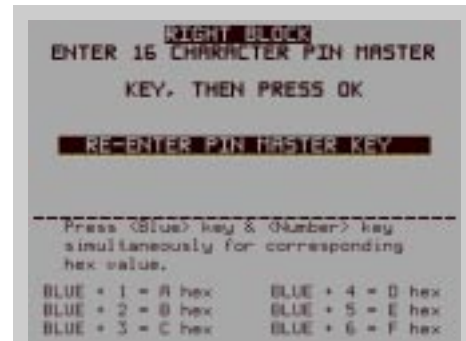

To enter a digit 0-9, simply press the key that has the desired digit, and a '*' will appear. To enter a Hex character (A through F), first press and hold down the <CTRL> key. While holding down the <CTRL> key, press the numbered key (1-6) that corresponds to the character you want to enter, as listed in the table on-screen (1=A, 2=B, 3=C, 4=D, 5=E, 6=F). A '*' character will appear. Release the <CTRL> key. Repeat for each character in the key. Press the <CHANGE> key to clear the entry and start over. Press the <LEFTARROW> key to back up and erase a character.

You must enter the key sequence TWICE for each KEY BLOCK: after the second entry, you will be prompted to enter a second key part. In most instances you will answer NO to this prompt, but in some cases a second sequence of characters may need to be entered (this requirement is processor-specific). requirement is processor-specific).

9700-SERIES

9705-SERIES

9710-SERIES

9750-SERIES

INJECT MASTER KEYS**FACTORY DEFAULT:** N/A**ACCESS INSTRUCTIONS:**

1. Select TERMINAL CONFIGURATION from the MANAGEMENT FUNCTIONS menu.
2. Select SET TERMINAL PARAMETERS.
3. Select KEY MANAGEMENT.
4. Choose the INJECT MASTER KEYS option.

DESCRIPTION:

The INJECT MASTER KEYS function is used in conjunction with a PC (Personnel Computer) and a special floppy disk to inject the master keys from the PC into a designated terminal. Selecting INJECT MASTER KEYS will cause the terminal to prepare for the load of the master keys from the PC, using a serial data cable.

ERROR CONDITIONS:

Do not connect the load port on the Cash Dispenser to the parallel (printer) port of the PC!

WRITING FOR KEY INJECTION

PRESS CANCEL TO QUIT

9700-SERIES

9705-SERIES

9710-SERIES

9750-SERIES

ENTER MAC WORKING KEY**FACTORY DEFAULT: PROCESSOR-SPECIFIC****ACCESS INSTRUCTIONS:**

1. Select TERMINAL CONFIGURATION from the MANAGEMENT FUNCTIONS menu.
2. Select SET TERMINAL PARAMETERS.
3. Select KEY MANAGEMENT.
4. Choose the ENTER MAC WORKING KEY option.

DESCRIPTION:

MAC is an acronym for Message Authentication Code. The MAC WORKING KEY is used to verify messages to and from the terminal. The MAC WORKING KEY is a 16-character string, consisting of the digits 0-9 and the letters A-F. Your processor must provide you with the MAC WORKING KEY. If a MAC authentication attempt on a message fails, the message will fail. This is a security precaution.

For security reasons, when entering this key, a '*' is displayed in place of the actual character. Since it is not possible to view the key while it is entered, the key must be entered in twice to make sure it was entered properly.

To enter a digit 0-9, simply press the key that has that digit, and a '*' will appear. To enter the letters A-F, first press the <CTRL> key, then press the key that has the letter you want on it. The first press of the key will display the first character above the number. Subsequent presses will display the characters in sequence. When the character you want is displayed, press the <RIGHT ARROW> key to 'lock in' the letter. If your next character is a letter, you must press the <CTRL> key again. Press the <CHANGE> key to clear the entry and start over. Press the <LEFT ARROW> key to back up and erase a character.

Normally, the MAC WORKING KEY contains only one part. However, some keys may contain multiple parts. If this is the case, separate individuals will hold the parts. If your key has multiple parts you must answer the question "ANOTHER KEY PART?", with a YES until all parts are entered.



ENTER 16 CHARACTER MAC WORKING
KEY. THEN PRESS 'OK'

RE-ENTER THE WORKING KEY



ENTER 16 CHARACTER MAC WORKING
KEY. THEN PRESS OK

RE-ENTER THE WORKING KEY

Press <Blue> key & <Number> key
simultaneously for corresponding
hex value.

BLUE + 1 = A hex	BLUE + 4 = D hex
BLUE + 2 = B hex	BLUE + 5 = E hex
BLUE + 3 = C hex	BLUE + 6 = F hex

In some versions of ATM software the MAC WORKING KEY entry screen accepts the digits 0-9 and the Hexadecimal ("Hex") characters A-F. On such screens, to enter a digit 0-9, simply press the key that has the desired digit. To enter a Hex character, first press and hold down the <CTRL> key. While holding down the <CTRL> key, press the numbered key (1-6) that corresponds to the character you want to enter, as listed in the table on-screen (1=A, 2=B, 3=C, 4=D, 5=E, 6=F). Release the <CTRL> key. Repeat for each character in the key. Press the <CHANGE> key to clear the entry and start over. Press the <LEFT ARROW> key to back up and erase a character.

If your key has multiple parts you must answer the question "ANOTHER KEY PART?", with a YES and enter the next key part until all parts are entered.

The CHECK DIGIT that appears after all parts of the MAC WORKING KEY have been entered is similar to the checksum that is used to verify that the data programmed into a memory device such as an EPROM is correct. The CHECK DIGIT can be verified by doing a RECEIPT PRINTER TEST from the DIAGNOSTICS Menu and comparing the MAC WORKING KEY CHECK DIGIT on the printout to the original receipt printout from the initial terminal setup. If the CHECK DIGIT is different from the original, and the terminal is not operating correctly, the MAC WORKING KEY is corrupt, and you should contact your service organization for assistance.

ERROR CONDITIONS:

If the MAC WORKING KEY is not entered correctly, no message traffic can take place, so be sure to enter the key accurately. If your second entry of the key does not match the first entry, you will be warned and allowed to start over with the first entry.

9700-SERIES

9705-SERIES

9710-SERIES

9750-SERIES

ENTER PIN WORKING KEY**FACTORY DEFAULT: PROCESSOR-SPECIFIC****ACCESS INSTRUCTIONS:**

1. Select TERMINAL CONFIGURATION from the MANAGEMENT FUNCTIONS menu.
2. Select SET TERMINAL PARAMETERS.
3. Select KEY MANAGEMENT.
4. Choose the ENTER PIN WORKING KEY option.

DESCRIPTION:**IMPORTANT**

The PIN MASTER KEY must be loaded BEFORE the PIN WORKING Key!

NOTE: In some versions of ATM software the PIN WORKING KEY is loaded automatically when the DOWNLOAD WORKING KEYS function is performed. In such versions, the PIN WORKING KEY option will not be available.

The PIN WORKING KEY is used to verify the customer Personal Identification Number during live transactions. This key is a 16-character string, consisting of the digits 0-9 and the letters A-F. Your processor must provide you with the PIN WORKING KEY.

For security reasons, when entering this key, a '*' is displayed in place of the actual character. Since it is not possible to view the key while it is entered, the key must be entered in twice to make sure it was entered properly.

To enter a digit 0-9, simply press the key that has that digit, and a '*' will appear. To enter the letters A-F, first press the <CTRL> key, then press the key that has the letter you want on it. The first press of the key will display the first character above the number. Subsequent presses will display the characters in sequence. When the character you want is displayed, press the <RIGHT ARROW> key to 'lock in' the letter. If your next character is a letter, you must press the <CTRL> key again. Press the <CHANGE> key to clear the entry and start over. Press the <LEFT ARROW> key to back up and erase a character.

ENTER 16 CHARACTER PIN WORKING
THEN PRESS 'OK'

RE-ENTER PIN WORKING KEY

ENTER 16 CHARACTER PIN WORKING
KEY, THEN PRESS OK

RE-ENTER PIN WORKING KEY

Press <Blue> key & <Number> key
simultaneously for corresponding
hex value.

BLUE + 1 = A hex	BLUE + 4 = D hex
BLUE + 2 = B hex	BLUE + 5 = E hex
BLUE + 3 = C hex	BLUE + 6 = F hex

In some versions of ATM software the PIN WORKING KEY entry screen accepts the digits 0-9 and the Hexadecimal ("Hex") characters A-F. On such screens, to enter a digit 0-9, simply press the key that has the desired digit. To enter a Hex character, first press and hold down the <CTRL> key. While holding down the <CTRL> key, press the numbered key (1-6) that corresponds to the character you want to enter, as listed in the table on-screen (1=A, 2=B, 3=C, 4=D, 5=E, 6=F). Release the <CTRL> key. Repeat for each character in the key. Press the <CHANGE> key to clear the entry and start over. Press the <LEFT ARROW> key to back up and erase a character.

If your key has multiple parts you must answer the question "ANOTHER KEY PART?", with a YES and enter the next key part until all parts are entered.

Normally, the PIN WORKINGKEY contains only one part. However, some keys may contain multiple parts. If this is the case, separate individuals will hold the parts. If your key has multiple parts you must answer the question "ANOTHER KEY PART?", with a YES until all parts are entered.

The CHECK DIGIT that appears after all parts of the PIN WORKINGKEY have been entered is similar to the checksum that is used to verify that the data programmed into a memory device such as an EPROM is correct. The CHECK DIGIT can be verified by doing a RECEIPT PRINTER TEST from the DIAGNOSTICS Menu and comparing the PIN WORKING KEY CHECK DIGIT on the printout to the original receipt printout from the initial terminal setup. If the CHECK DIGIT is different from the original, and the terminal is not operating correctly, the PIN WORKING KEY is corrupt, and you should contact your service organization for assistance.

ERROR CONDITIONS:

If the PIN WORKING KEY is not entered correctly, no message traffic can take place, so be sure to enter the key accurately. If your second entry of the key does not match the first entry, you will be warned and allowed to start over with the first entry.

9700-SERIES

9705-SERIES

9710-SERIES

9750-SERIES

DOWNLOAD WORKING KEYS**FACTORY DEFAULT: PROCESSOR-SPECIFIC****ACCESS INSTRUCTIONS:**

1. Select TERMINAL CONFIGURATION from the MANAGEMENT FUNCTIONS menu.
2. Select SET TERMINAL PARAMETERS.
3. Select KEY MANAGEMENT.
4. Choose the DOWNLOAD WORKING KEYS option.

DESCRIPTION:

The WORKING KEYS are the MAC and PIN WORKING KEYS, as described earlier. They are made up of 16-character strings, consisting of the digits 0-9 and the letters A-F. Your processor may provide you with the WORKING KEYS, or they may be downloaded from the processor host computer.

These keys must be loaded before the Cash Dispenser can operate in a live mode.

When the DOWNLOAD WORKING KEYS function is run, a call is placed to your host computer, and a request is made for the keys to be sent. The host will send the keys and several other parameters (such as the surcharge amount, if applicable). Once downloaded, these parameters will remain in the Cash Dispenser, even if it is turned off.

The TERMINAL number and primary phone number must be set before completing this function. If they are not set correctly, the WORKING KEYS will not be downloaded.

ERROR CONDITIONS:

If the call cannot be completed, a warning screen will be displayed. If the function continues to fail, contact your service organization for assistance.



CONFIGURATION TABLE
DOWNLOADED
PRESS CANCEL TO CONTINUE

9700-SERIES

9705-SERIES

9710-SERIES

9750-SERIES

TELEPHONE**FACTORY DEFAULT: N/A****ACCESS INSTRUCTIONS:**

1. Select TERMINAL CONFIGURATION from the MANAGEMENT FUNCTIONS menu.
2. Select SET TERMINAL PARAMETERS.
3. Select TELEPHONE.

DESCRIPTION:

The TELEPHONE function is used to set up parameters that control telephone communications between the Cash Dispenser and the Processor. The following parameters are accessed through this function.

1. PRIMARY NUMBER
2. BACKUP NUMBER
3. DATAPAK ACCESS CODE (This feature is only available for ATMs deployed in Canada.)
4. PREDIAL ON/OFF
5. COMPUSERVE ID
6. MODEM SETUP

ERROR CONDITIONS:

There are no error conditions directly associated with this function.



9700-SERIES

9705-SERIES

9710-SERIES

9750-SERIES

PRIMARY NUMBER**FACTORY DEFAULT: NONE****ACCESS INSTRUCTIONS:**

1. Select TERMINAL CONFIGURATION from the MANAGEMENT FUNCTIONS menu.
2. Select SET TERMINAL PARAMETERS.
3. Select TELEPHONE.
4. Select the PRIMARY NUMBER option.

DESCRIPTION:

The Cash Dispenser communicates to your host processor over a dial up phone line. The phone number of the processor must be entered before live transactions can be done.

When this function is selected, the current phone number is displayed (if nothing appears on the screen, no number is set). Select CHANGE to blank the current entry, and then enter the desired phone number. The phone number may be up to 15 digits long. It can also contain a dialing prefix, such as a '9' for an outside line, if necessary. If you need to pause after the prefix, place a comma in the number for a two-second delay at that point. Pressing the <CTRL> key first, then the <0> key, followed by the <RIGHT ARROW> key will select the comma character. Make sure to enter the long distance prefix '1' if you are dialing an 800 number or a toll long distance number. Do not enter dashes in the number.

ERROR CONDITIONS:

The Cash Dispenser will not process transactions if the phone number has not been entered or has been entered incorrectly. In such cases error code "185 - Phone Number Not Configured", will be received.



9700-SERIES

9705-SERIES

9710-SERIES

9750-SERIES

BACKUP NUMBER**FACTORY DEFAULT: NONE****ACCESS INSTRUCTIONS:**

1. Select TERMINAL CONFIGURATION from the MANAGEMENT FUNCTIONS menu.
2. Select SET TERMINAL PARAMETERS.
3. Select TELEPHONE.
4. Select the BACKUP NUMBER option.

DESCRIPTION:

The Cash Dispenser communicates with your Processors' host computer over a dial up phone line. Some processors allow a backup phone number to try if the primary number fails to connect.

When this function is selected, the current phone number is displayed (if nothing appears on the screen, no number is set). Select CHANGE to blank the current entry, and then enter the desired phone number. The phone number may be up to 15 digits long. It can also contain a dialing prefix, such as a '9' for an outside line, if necessary. If you need to pause after the prefix, place a comma in the number for a two-second delay at that point. Pressing the <CTRL> key first, then the <0> key, followed by the <RIGHT ARROW> select the comma. Make sure to enter the long distance prefix '1' if you are dialing an 800 number or a toll long distance number. Do not enter dashes in the number.

ERROR CONDITIONS:

There are no error conditions directly associated with this function.



9700-SERIES

9705-SERIES

9710-SERIES

9750-SERIES

DATAPAK ACCESS CODE**FACTORY DEFAULT: N/A****ACCESS INSTRUCTIONS:**

1. Select TERMINAL CONFIGURATION from the MANAGEMENT FUNCTIONS menu.
2. Select SET TERMINAL PARAMETERS.
3. Select TELEPHONE.
4. Select DATAPAK ACCESS CODE.

DESCRIPTION:

NOTE: This feature is only available for Canadian-region ATMs.

This function allows you to enter the DATAPAK ACCESS CODE, and to turn the DataPak feature On or OFF. The DATAPAK ACCESS CODE is provided by the DataPak processing organization, and is an identification number which enables the DataPak processing organization to correctly identify and route data traffic between the terminal and the transaction processor.

The current state of the DATAPAK ACCESS CODE feature is shown as either ON or OFF in the label on the left-hand side of the display. Press the button next to this label to toggle the state of the feature between ON and OFF.

IMPORTANT: When using the DATAPAK communications protocol, ensure the terminal's Primary and Backup Telephone Numbers are configured to dial the DataPak processing organization (NOT the transaction processor!).

ERROR CONDITIONS:

If a DATAPAK-based communications network is being used, the DATAPAK ACCESS CODE feature must be turned ON and the code must be entered correctly to enable message traffic between the ATM and the processor to take place.



9700-SERIES

9705-SERIES

9710-SERIES

9750-SERIES

PREDIAL ON/OFF**FACTORY DEFAULT: OFF****ACCESS INSTRUCTIONS:**

1. Select TERMINAL CONFIGURATION from the MANAGEMENT FUNCTIONS menu.
2. Select SET TERMINAL PARAMETERS.
3. Select TELEPHONE.

DESCRIPTION:

This function allows you to turn on or off the PREDIAL feature. When the feature is turned ON, the terminal will dial out to the processor and establish a connection as soon as the customer's ATM or credit card has been scanned by the card reader. The purpose of this mode of operation is to provide quicker processing of customer transactions. When the feature is turned OFF, the terminal will wait until the customer has selected a particular transaction before dialing out and establishing a connection with the processor.

The current state of the PREDIAL feature is shown as either ON or OFF in the label on the left-hand side of the display. Press the button next to this label to toggle the state of the feature between ON and OFF.

ERROR CONDITIONS:

There are no error conditions directly associated with this function.

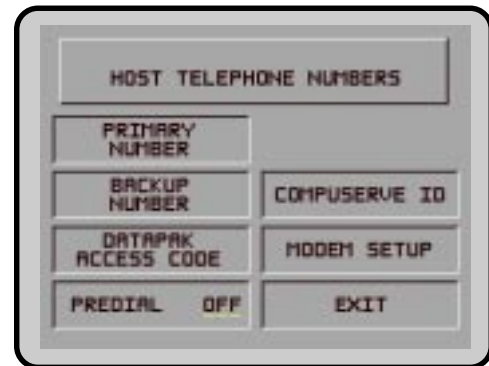

9700-SERIES

9705-SERIES

9710-SERIES

9750-SERIES

COMPUSERVE ID**FACTORY DEFAULT:** NONE**ACCESS INSTRUCTIONS:**

1. Select TERMINAL CONFIGURATION from the MANAGEMENT FUNCTIONS menu.
2. Select SET TERMINAL PARAMETERS.
3. Select TELEPHONE.
4. Select the COMPUSERVE ID option.

DESCRIPTION:

The CompuServe Network is used by some processors to route transactions. The COMPUSERVE ID function allows the terminal operator or a service technician to view and change the COMPUSERVE ROUTING ID number.

When this function is selected, the current CompuServe ID is displayed (if nothing appears on the screen, no ID is set). Select CHANGE to blank the current entry, and then enter the desired ID number. When done, press OK to accept the entry.

ERROR CONDITIONS:

When CompuServe is used as the communication media for sending and receiving transaction data to the Processor, an incorrect CompuServe ID will cause communication between the terminal and the Processor to fail. Never change the COMPUSERVE ID unless instructed to do so by your processor.



9700-SERIES

9705-SERIES

9710-SERIES

9750-SERIES

MODEM SETUP**FACTORY DEFAULT: N/A****ACCESS INSTRUCTIONS:**

1. Select TERMINAL CONFIGURATION from the MANAGEMENT FUNCTIONS menu.
2. Select SET TERMINAL PARAMETERS.
3. Select TELEPHONE.
4. Select the MODEM SETUP option.

DESCRIPTION:

Selecting the MODEM SETUP OPTION from the TELEPHONE screen allows the terminal operator to select the following parameters:

1. DIAL MODE
2. DIAL RATE
3. BAUD RATE
4. MODEM SETUP STRING
5. RESET/TEST MODEM

ERROR CONDITIONS:

There are no error conditions directly associated with this function.

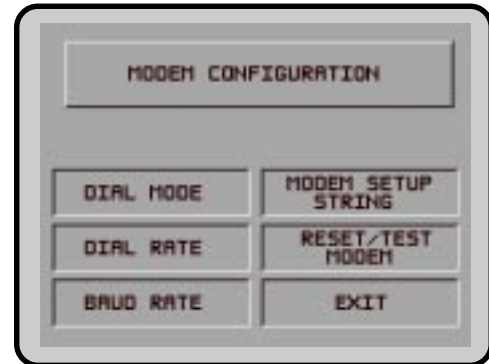

9700-SERIES

9705-SERIES

9710-SERIES

9750-SERIES

DIAL MODE**FACTORY DEFAULT: 'DTMF'****ACCESS INSTRUCTIONS:**

1. Select TERMINAL CONFIGURATION from the MANAGEMENT FUNCTIONS menu.
2. Select SET TERMINAL PARAMETERS.
3. Select TELEPHONE.
4. Select the MODEM SETUP option.
5. Select DIAL MODE.

DESCRIPTION:

The modem is configured to dial in either the touch-tone mode (DTMF), or in the rotary (PULSE) mode. Consult with the local phone company to determine which option is supported. After selecting the dial mode, be certain to execute the RESET/TEST MODEM function. The new dial mode does not take effect until you do this. The factory default for the function is DTMF.

ERROR CONDITIONS:

If the local phone exchange does not support touch-tone, and the terminal is configured for DTMF mode, no calls will be completed. Rotary will work on touch-tone systems, but should not be used if touch-tone is available. Rotary mode will dial much slower than DTMF.



9700-SERIES

9705-SERIES

9710-SERIES

9750-SERIES

DIAL RATE**FACTORY DEFAULT: 'FAST'****ACCESS INSTRUCTIONS:**

1. Select TERMINAL CONFIGURATION from the MANAGEMENT FUNCTIONS menu.
2. Select SET TERMINAL PARAMETERS.
3. Select TELEPHONE.
4. Select the MODEM SETUP option.
5. Select DIAL RATE.

DESCRIPTION:

The internal modem can be configured to send dial tones at one of three speeds. The possible values are FAST (70 milliseconds), MED. (150 ms), and SLOW (255 ms). The default value from the factory is FAST. After changing the dial rate, be certain to execute the RESET/TEST MODEM function. The new dial rate does not take effect until you do this.

ERROR CONDITIONS:

There are no error conditions directly associated with this function, but if calls seem to fail, try a slower setting.



9700-SERIES

9705-SERIES

9710-SERIES

9750-SERIES

BAUD RATE**FACTORY DEFAULT:** '1200'**ACCESS INSTRUCTIONS:**

1. Select TERMINAL CONFIGURATION from the MANAGEMENT FUNCTIONS menu.
2. Select SET TERMINAL PARAMETERS.
3. Select TELEPHONE.
4. Select the MODEM SETUP option.
5. Select BAUD RATE.

DESCRIPTION:

The bit rate of the modem can be controlled with this function. The rate can be set to 2400 or 1200 bits per second (bps). The default rate depends on your processor. Do not select 2400 if your processor does not support it.

ERROR CONDITIONS:

If the speed of the modem is set to 2400 bps, it may not connect to a 1200 bps system. The baud rate of the modem should always be set to the value indicated by your processor.



9700-SERIES	9705-SERIES	9710-SERIES	9750-SERIES
-------------	-------------	-------------	-------------

MODEM SETUP STRING

FACTORY DEFAULT: MODEM-SPECIFIC

ACCESS INSTRUCTIONS:

1. Select TERMINAL CONFIGURATION from the MANAGEMENT FUNCTIONS menu.
2. Select SET TERMINAL PARAMETERS.
3. Select TELEPHONE.
4. Select the MODEM SETUP option.
5. Select MODEM SETUP STRING.

DESCRIPTION:

If special circumstances require a nonstandard modem configuration, a Hayes-compatible setup string can be sent to the modem when it is initialized. A custom modem initialization string can be entered for the following options:

1. INITIALIZE STRING
2. PRE-HOST STRING
3. POST-HOST STRING
4. TRITON CONNECT STRING

When an option is selected, the current modem string for that function is displayed (if nothing appears on the screen, no string has been entered). Select CHANGE to blank the current entry, and then enter the desired modem string. When done, press OK to accept the entry.

ERROR CONDITIONS:

Setting this value incorrectly can cause communication failure in the applicable area, due to improper modem setup. Consult Triton's Technical Service Department before changing this parameter.



9700-SERIES

9705-SERIES

9710-SERIES

9750-SERIES

RESET/TEST MODEM**FACTORY DEFAULT: N/A****ACCESS INSTRUCTIONS:**

1. Select TERMINAL CONFIGURATION from the MANAGEMENT FUNCTIONS menu.
2. Select SET TERMINAL PARAMETERS.
3. Select TELEPHONE.
4. Select the MODEM SETUP option.
5. Select RESET/TEST MODEM.

DESCRIPTION:

This function is used to reset and test the internal modem. It should be run after setting any of the modem configuration parameters to make sure an error was not made. It MUST be run after changing the DIAL MODE or DIAL RATE, otherwise these new values will not take effect until the unit is turned off and back on again.

At the conclusion of the test a screen will appear indicating that the MODEM CONFIGURED AND TESTED OK.

ERROR CONDITIONS:

An error message will indicate a problem if the setup string is invalid or the modem is not responding.



```
MODEM TESTING / INITIALIZATION
IN PROGRESS

PLEASE WAIT
```

9700-SERIES

9705-SERIES

9710-SERIES

9750-SERIES

MORE (TERMINAL PARAMETERS)**FACTORY DEFAULT: N/A****ACCESS INSTRUCTIONS:**

1. Select TERMINAL CONFIGURATION from the MANAGEMENT FUNCTIONS menu.
2. Select SET TERMINAL PARAMETERS.
3. Choose MORE.

DESCRIPTION:

Selecting the MORE TERMINAL PARAMETERS option from the TERMINAL PARAMETERS allows the terminal operator or a service technician to view or change the following:

1. ADJUST CONTRAST
2. RECEIPT OPTION
3. TRITON CONNECT
4. ATM MONITORING
5. AD SCREENS
6. COMMUNICATION HEADER
7. MORE

ERROR CONDITIONS:

There are no error conditions directly associated with this function.



9700-SERIES

9705-SERIES

9710-SERIES

9750-SERIES

ADJUST CONTRAST**FACTORY DEFAULT: CONTRAST: MID-RANGE****ACCESS INSTRUCTIONS:**

1. Select TERMINAL CONFIGURATION from the MANAGEMENT FUNCTIONS menu.
2. Select SET TERMINAL PARAMETERS.
3. Select MORE.
4. Choose ADJUST CONTRAST.

DESCRIPTION:

This feature allows the terminal operator to adjust the contrast of the display.

Change the contrast of the display by selecting the designated UP or DOWN key to set the display contrast for best viewing.

ERROR CONDITIONS:

There are no error conditions directly associated with this function.



9700-SERIES

9705-SERIES

9710-SERIES

9750-SERIES

RECEIPT OPTION**FACTORY DEFAULT: DISABLED****ACCESS INSTRUCTIONS:**

1. Select TERMINAL CONFIGURATION from the MANAGEMENT FUNCTIONS menu.
2. Select SET TERMINAL PARAMETERS.
3. Select MORE.
4. Choose RECEIPT OPTION.

DESCRIPTION:

This feature allows the customer to select the option of receiving or not receiving a receipt at the completion of a transaction. When RECEIPT OPTION is ENABLED the customer is presented with a message at the conclusion of the transaction asking whether they want a receipt or not. If they respond NO to the question, a receipt is not dispensed. If they respond YES to the question a receipt is printed. If the customer does not respond to the question, a receipt is automatically printed after a forty-second delay.

If you don't want the customer to have this option, DISABLE the RECEIPT OPTION. Customers will then receive a receipt after every transaction.

ERROR CONDITIONS:

There are no error conditions directly associated with this function.



9700-SERIES

9705-SERIES

9710-SERIES

9750-SERIES

TRITON CONNECT**FACTORY DEFAULT: DISABLED****ACCESS INSTRUCTIONS:**

1. Select TERMINAL CONFIGURATION from the MANAGEMENT FUNCTIONS menu.
2. Select SET TERMINAL PARAMETERS.
3. Select MORE.
4. Choose TRITON CONNECT.

DESCRIPTION:

Selecting the TRITON CONNECT function allows the terminal operator to set up the following parameters associated with Triton Connect:

1. PRIMARY NUMBER
2. BACKUP NUMBER
3. ALARM NUMBERS
4. CALL BACK (ENABLE\DISABLE)
5. TRITON CONNECT (ENABLE\DISABLE)

NOTE: Triton Connect is an option and may not be installed on your terminal.

ERROR CONDITIONS:

There are no error conditions directly associated with this function.

**WHAT IS TRITON CONNECT?**

Triton Connect is PC (Personal Computer) based software that enables you to remotely your terminals.

Triton Connect increases efficiency and reduces costs associated with managing terminals. Significant advantages include:

Operation on a single, stand-alone PC or in a networked environment

Can perform a wide range of monitoring and control functions from a central location.

Supports CDPD (cellular-wireless), dial-up and satellite communications with remote terminals.

9700-SERIES

9705-SERIES

9710-SERIES

9750-SERIES

PRIMARY NUMBER**FACTORY DEFAULT: NONE****ACCESS INSTRUCTIONS:**

1. Select TERMINAL CONFIGURATION from the MANAGEMENT FUNCTIONS menu.
2. Select SET TERMINAL PARAMETERS.
3. Select MORE.
4. Select TRITON CONNECT.
5. Choose PRIMARY NUMBER.

DESCRIPTION:

The PRIMARY NUMBER function is used to enter the number that the terminal can use for calling back the Triton Connect Host Computer.

When this function is selected, the current phone number is displayed (if nothing appears on the screen, no number is set). Select CHANGE to blank the current entry, and then enter the desired phone number. The phone number may be up to 15 digits long. It can also contain a dialing prefix, such as a '9' for an outside line, if necessary. If you need to pause after the prefix, place a comma in the number for a two-second delay at that point. Pressing the <CTRL> key first, then the <0> key, followed by the <RIGHT ARROW> key to select the comma character. Make sure to enter the long distance prefix '1' if you are dialing an 800 number or a toll long distance number. Do not enter dashes in the number.

ERROR CONDITIONS::

There are no error conditions directly associated with this function.



9700-SERIES

9705-SERIES

9710-SERIES

9750-SERIES

BACKUP NUMBER**FACTORY DEFAULT: NONE****ACCESS INSTRUCTIONS:**

1. Select TERMINAL CONFIGURATION from the MANAGEMENT FUNCTIONS menu.
2. Select SET TERMINAL PARAMETERS.
3. Select MORE.
4. Select TRITON CONNECT.
5. Choose BACKUP NUMBER.

DESCRIPTION:

The BACKUP NUMBER function is used to enter a backup number that the terminal can use for calling back the Triton Connect computer.

When this function is selected, the current phone number is displayed (if nothing appears on the screen, no number is set). Select CHANGE to blank the current entry, and then enter the desired phone number. The phone number may be up to 15 digits long. It can also contain a dialing prefix, such as a '9' for an outside line, if necessary. If you need to pause after the prefix, place a comma in the number for a two-second delay at that point. Press the <CTRL> key, then the <0> key, followed by the <RIGHT ARROW> key to select the comma character. Make sure to enter the long distance prefix '1' if you are dialing an 800 number or a toll long distance number. Do not enter dashes in the number.

ERROR CONDITIONS:

There are no error conditions directly associated with this function.



9700-SERIES

9705-SERIES

9710-SERIES

9750-SERIES

ALARM NUMBERS**FACTORY DEFAULT: N/A****ACCESS INSTRUCTIONS:**

1. Select TERMINAL CONFIGURATION from the MANAGEMENT FUNCTIONS menu.
2. Select SET TERMINAL PARAMETERS.
3. Select MORE.
4. Choose TRITON CONNECT.
5. Choose ALARM NUMBERS.

DESCRIPTION:

In some applications the terminal monitoring organization may require different telephone numbers for alarm reporting purposes. This could enable a third party service organization, for example, to be notified of alarm conditions that can occur during non-business hours. Selecting the ALARM NUMBERS option brings up a menu that allows the terminal operator to select and configure the Primary and Backup Triton Connect Alarm Numbers.

NOTE: Triton Connect is an option and may not be installed on your terminal.

ERROR CONDITIONS:

There are no error conditions directly associated with this function.



9700-SERIES

9705-SERIES

9710-SERIES

9750-SERIES

PRIMARY ALARM NUMBER**FACTORY DEFAULT: NONE****ACCESS INSTRUCTIONS:**

1. Select TERMINAL CONFIGURATION from the MANAGEMENT FUNCTIONS menu.
2. Select SET TERMINAL PARAMETERS.
3. Select MORE.
4. Select TRITON CONNECT.
5. Select ALARM NUMBERS.
6. Choose PRIMARY.

DESCRIPTION:

The PRIMARY ALARM NUMBER function is used to enter the telephone number that the terminal can use for calling back the Triton Connect Host Computer.

When this function is selected, the current phone number is displayed (if nothing appears on the screen, no number is set). Select CHANGE to blank the current entry, and then enter the desired phone number. The phone number may be up to 15 digits long. It can also contain a dialing prefix, such as a '9' for an outside line, if necessary. If you need to pause after the prefix, place a comma in the number for a two-second delay at that point. Pressing the <CTRL> key first, then the <0> key, followed by the <RIGHT ARROW> key to select the comma character. Make sure to enter the long distance prefix '1' if you are dialing an 800 number or a toll long distance number. Do not enter dashes in the number.

ERROR CONDITIONS::

There are no error conditions directly associated with this function.

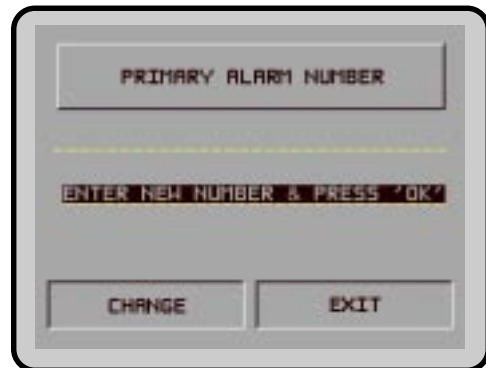

9700-SERIES

9705-SERIES

9710-SERIES

9750-SERIES

BACKUP ALARM NUMBER**FACTORY DEFAULT: NONE****ACCESS INSTRUCTIONS:**

1. Select TERMINAL CONFIGURATION from the MANAGEMENT FUNCTIONS menu.
2. Select SET TERMINAL PARAMETERS.
3. Select MORE.
4. Select TRITON CONNECT.
5. Select ALARM NUMBERS.
6. Choose BACKUP.

DESCRIPTION:

The BACKUP ALARM NUMBER function is used to enter a backup telephone number that the terminal can use for calling back the Triton Connect computer.

When this function is selected, the current phone number is displayed (if nothing appears on the screen, no number is set). Select CHANGE to blank the current entry, and then enter the desired phone number. The phone number may be up to 15 digits long. It can also contain a dialing prefix, such as a '9' for an outside line, if necessary. If you need to pause after the prefix, place a comma in the number for a two-second delay at that point. Press the <CTRL> key, then the <0> key, followed by the <RIGHT ARROW> key to select the comma character. Make sure to enter the long distance prefix '1' if you are dialing an 800 number or a toll long distance number. Do not enter dashes in the number.

ERROR CONDITIONS:

There are no error conditions directly associated with this function.



9700-SERIES

9705-SERIES

9710-SERIES

9750-SERIES

ENABLE/DISABLE CALL BACK**FACTORY DEFAULT: DISABLED****ACCESS INSTRUCTIONS:**

1. Select TERMINAL CONFIGURATION from the MANAGEMENT FUNCTIONS menu.
2. Select SET TERMINAL PARAMETERS.
3. Select MORE.
4. Select TRITON CONNECT.

DESCRIPTION:

Normally, when the Triton Connect Host Computer contacts a terminal, it will hang up and wait for the terminal to CALL BACK. This is done for security reasons. The CALL BACK option allows the terminal operator to enable and disable this feature.

Once you've reached the TRITON CONNECT screen, the CALL BACK button will present an option to reverse the current state of the feature. For example, if CALL BACK is currently ENABLED, the CALL BACK option button will show the DISABLE CALL BACK option. Conversely, if CALL BACK is currently DISABLED, the CALL BACK option button will show the ENABLE CALL BACK option.

ERROR CONDITIONS:

There are no error conditions directly associated with this function.



9700-SERIES

9705-SERIES

9710-SERIES

9750-SERIES

ENABLE/DISABLE TRITON CONNECT**FACTORY DEFAULT: DISABLED****ACCESS INSTRUCTIONS:**

1. Select TERMINAL CONFIGURATION from the MANAGEMENT FUNCTIONS menu.
2. Select SET TERMINAL PARAMETERS.
3. Select MORE.
4. Select TRITON CONNECT.

DESCRIPTION:

If the Triton Connect feature has been ACTIVATED (using the ACTIVATE function), this function can be used to ENABLE or DISABLE Triton Connect access to the terminal.

Once you've reached the TRITON CONNECT screen, the TRITON CONNECT button will present an option to reverse the current state of this feature. For example, if Triton Connect is currently ENABLED, the button will show the DISABLE TRITON CONNECT option. Conversely, if Triton Connect is currently DISABLED, the option button will show the ENABLE TRITON CONNECT option.

ERROR CONDITIONS:

There are no error conditions directly associated with this function.



9700-SERIES

9705-SERIES

9710-SERIES

9750-SERIES

ATM MONITORING**FACTORY DEFAULT: N/A****ACCESS INSTRUCTIONS:**

1. Select TERMINAL CONFIGURATION from the MANAGEMENT FUNCTIONS menu.
2. Select SET TERMINAL PARAMETERS.
3. Select MORE.
4. Select ATM monitoring.

DESCRIPTION:

The ATM Monitoring screen provides access to the following functions:

1. STATUS MONITORING. When this feature is enabled the terminal will send operational status information to the processor during the certain transactions.
2. HEARTBEAT MESSAGE. The Heartbeat Message feature is designed to provide a means of reporting communications system status to the host processor.

ERROR CONDITIONS:

There are no error conditions directly associated with this function.

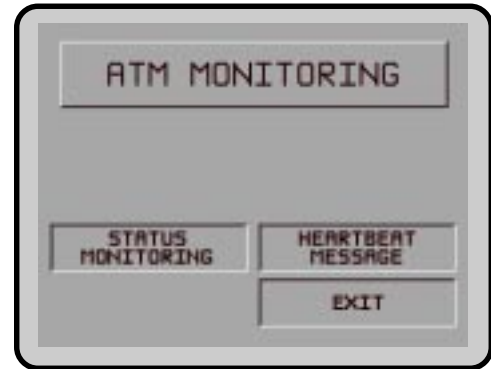

9700-SERIES

9705-SERIES

9710-SERIES

9750-SERIES

STATUS MONITORING**FACTORY DEFAULT: DISABLED****ACCESS INSTRUCTIONS:**

1. Select TERMINAL CONFIGURATION from the MANAGEMENT FUNCTIONS menu.
2. Select SET TERMINAL PARAMETERS.
3. Select MORE.
3. Select ATM MONITORING.
4. Select Status monitoring.

DESCRIPTION:

Status monitoring is a feature that is available with selected processor software. When enabled the terminal will send operational status information to the processor during certain transactions with the processor. The status information is sent in a data field that is part of any of the following messages sent to the processor:

1. A Transaction Request Message
2. Configuration Table Download Request Message (Comms Key Download)
3. Host Totals Download Request Message
4. Reversal Request Message.

Turn this feature on by selecting the ENABLE option on this screen. Select DISABLE to inhibit the operation of the STATUS MONITORING feature.

ERROR CONDITIONS:

There are no error conditions directly associated with this function.



9700-SERIES

9705-SERIES

9710-SERIES

9750-SERIES

HEARTBEAT MESSAGE**FACTORY DEFAULT: DISABLED****ACCESS INSTRUCTIONS:**

1. Select TERMINAL CONFIGURATION from the MANAGEMENT FUNCTIONS menu.
2. Select SET TERMINAL PARAMETERS.
3. Select MORE.
4. Select ATM MONITORING.
5. Select HEARTBEAT MESSAGE.

DESCRIPTION:

The HEARTBEAT MESSAGE feature is designed to provide a means of reporting communications system status to the host processor.

Status reporting by dial-up ATMs is now the norm, but the single most important feature that cannot be monitored is the communications status. The absence of transactions from a particular terminal can mean one of two things. Usually the lack of calls indicates nothing more than a slow period. Sometimes, though, a piece of the communications system will fail and inhibit any calls from being made. The host has no way of determining which scenario is occurring in any kind of real-time mode. The Heartbeat Message overcomes this limitation.

When this feature is ENABLED, the terminal will call the host after a period of inactivity. During this call, the terminal will request a COMMS KEY DOWNLOAD (the normal configuration download request), and will also report status (if the STATUS MONITORING function is ENABLED). This allows the host to determine if a particular terminal is still in operation, even though it may not be performing any transactions at the time. With this feature enabled, the host can finally monitor communications system failures.

The Heartbeat Message feature on the Cash Dispenser has several parameters that must be set to operate properly. These parameters are:

1. HEARTBEAT MESSAGE. This parameter turns on or off the regular call to the host.
2. DELAY PERIOD. This parameter sets the time interval that must expire before a Heartbeat Message will be sent. It is specified in minutes.

HEARTBEAT MESSAGE IS: ENABLED
AND
THE DELAY PERIOD IS: _____ MINUTES

ENABLE

CHANGE
DELAY PERIOD

DISABLE

EXIT

Once the Heartbeat Message call feature is enabled at the terminal, an internal timer will be initialized to the number of minutes set in the DELAY PERIOD parameter at system power-up and after a reset. This timer is restarted each time a call is made to the host. A call to the host is defined as any transaction, including financial, balancing and configuration that actually communicates with the host to the point that the Terminal ID is recognized. A customer transaction that is declined will reset the timer, while a call that fails because the host phone number was busy would not.

It is important to remember that as long as transactions are being done on the terminal on a regular basis, Heartbeat Message calls will not be made. The sole purpose of these calls is to let the host know that the terminal is OK when it is NOT performing regular transactions.

Because the primary purpose of the Heartbeat Message call is to let the host know everything is all right, a Heartbeat Message call that DOES NOT succeed for any reason is not retried. If the call does fail, the interval timer will be reset and the terminal will remain in service.

While the concept of the Heartbeat Message call is simple, interpreting the absence of an expected call must be explained. Listed below are reasons why Heartbeat Message calls will not be received at the host either when expected or at all.

Feature Not Turned On

Obviously, if the feature is not enabled, no Heartbeat Message calls will be made.

Terminal is Doing Transactions

If the terminal does at least one regular customer transaction or balancing transaction before the interval timer, no Heartbeat Message call will be made.

Terminal is in Management Function Mode

Heartbeat Message calls are suspended while the terminal is in the Management mode, although the interval timer continues to run. If the timer expires while the terminal is in this mode, the call will be delayed until the terminal returns to the normal service mode.

Terminal is Out of Service

When the terminal goes out of service, one Heartbeat Message call is made. After that call, all further calls are suspended until it is returned to normal service.

Terminal is Turned Off or Power Has Failed

If the terminal is turned off, no calls will be made. While an obvious point, it means that for this feature to be of any value, the terminal must always remain on.

Communications System Has Failed

A failure of any piece of the communications system will result in missed calls. This includes the terminal modem, the phone line to the terminal, and any intermediate telecommunications providers.

Terminal Was Reset or Power Cycled

Since the interval timer is reset when the terminal is reset, a scheduled call may not occur at the expected time.

To realize the benefits of the Heartbeat Message, the host must be programmed to monitor the interval between calls from the terminal. It is important to note, though, that the host interval threshold should be set to a value greater than that programmed at the terminal. A practical guideline is at least twice the terminal interval. This allows for Heartbeat Message calls that are delayed because the terminal is in Management mode, or calls skipped because of a system reset.

ERROR CONDITIONS:

There are no error conditions directly associated with this function.

9700-SERIES

9705-SERIES

9710-SERIES

9750-SERIES

AD SCREENS**FACTORY DEFAULT: ENABLED****ACCESS INSTRUCTIONS:**

1. Select TERMINAL CONFIGURATION from the MANAGEMENT FUNCTIONS menu.
2. Select SET TERMINAL PARAMETERS.
3. Select MORE.
4. Select AD SCREENS.

DESCRIPTION:

The terminal must have at least one Memory Expansion Card installed for this feature to operate. AD SCREENS is a feature that causes the display on an idle terminal to alternate between the WELCOME SCREEN and a screen containing graphics and text elements used to make an advertisement screen. AD SCREENS are created in a special graphics editor that runs from the Triton Connect Terminal Managers program. The graphics editor lets the user import 16-color bit-mapped graphic files in the '.bmp' format with a maximum resolution of 320 dots by 240 dots. The graphic can then be relocated in the display area. Then text can be added to the display and the graphic and text are saved in the proprietary '.TCG' (Triton Connect Graphic) file format. TCG files can then be downloaded to the terminals' Expansion Memory Card for display on the screen. In addition to the graphic, data is also downloaded that establishes what time of day and for how long the Ad Screen is displayed.

Selecting ENABLE from the AD SCREENS Menu turns on the AD SCREENS feature. Selecting DISABLE turns off the feature.

ERROR CONDITIONS:

There are no error conditions directly associated with this function.



9700-SERIES

9705-SERIES

9710-SERIES

9750-SERIES

COMMUNICATION HEADER**FACTORY DEFAULT: PROCESSOR-SPECIFIC****ACCESS INSTRUCTIONS:**

1. Select TERMINAL CONFIGURATION from the MANAGEMENT FUNCTIONS menu.
2. Select SET TERMINAL PARAMETERS.
3. Select MORE.
4. Select COMMUNICATION HEADER.

DESCRIPTION:

The COMMUNICATION HEADER is an optional feature that is only applicable to certain processors. When a specified processor requires the use of the COMMUNICATIONS HEADER it must be ENABLED and have the correct data in the header data field. The COMMUNICATION HEADER data field consists of alphanumeric characters.

To enter a digit 0-9, press the key that has that digit. To enter a letter, first press the <CTRL> key, then press the key that has the letter you want on it. The first press of the key will display the first character above the number. Subsequent presses will display the characters in sequence. When the character you want is displayed, press the <RIGHT ARROW> key to 'lock in' the character. If your next character is a letter, you must press the <CTRL> key again.

ERROR CONDITIONS:

Enabling the COMMUNICATION HEADER when using a processor that doesn't use this feature will prevent any type of transaction from completing. Disabling or having incorrect data in the COMMUNICATION HEADER data field (if the feature is required) will also prevent any type of transaction from processing.



9700-SERIES

9705-SERIES

9710-SERIES

9750-SERIES

MORE (TERMINAL PARAMETERS)**FACTORY DEFAULT: N/A****ACCESS INSTRUCTIONS:**

1. Select TERMINAL CONFIGURATION from the MANAGEMENT FUNCTIONS menu.
2. Select SET TERMINAL PARAMETERS.
3. Select MORE.
4. Select MORE.

DESCRIPTION:

This screen allows you to select additional terminal parameters functions. The functions available are:

1. ALARM THRESHOLDS
2. BACKGROUND GRAPHICS
3. VIEW/MODIFY OPTIONS

The ALARM THRESHOLDS function is used to monitor the status of various parameters (such as number of journal entries, or the level of cash remaining in the cassette), and determines at what point a notification message will be sent to a remote computer. This remote computer must be running Triton Connect monitoring software.

The BACKGROUND GRAPHICS function is used to turn ON or OFF the display of background graphics, and to select the currently displayed background graphic image.

The VIEW/MODIFY OPTIONS function is used to activate or deactivate special terminal features such as Triton Connect.

ERROR CONDITIONS:

There are no error conditions directly associated with this function.

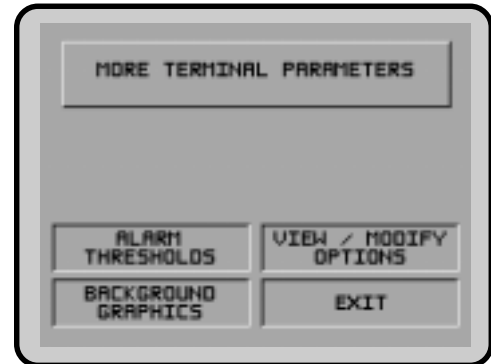

9700-SERIES

9705-SERIES

9710-SERIES

9750-SERIES

ALARM THRESHOLDS**FACTORY DEFAULT: OFF****ACCESS INSTRUCTIONS:**

1. Select TERMINAL CONFIGURATION from the MANAGEMENT FUNCTIONS menu.
2. Select SET TERMINAL PARAMETERS.
3. Select MORE.
4. Select MORE.
5. Select ALARM THRESHOLDS.

DESCRIPTION:

This function allows you to turn on or off the LOW CASH THRESHOLD, JOURNAL THRESHOLD, and SCHEDULED JOURNAL features.

1. **LOW CASH THRESHOLD.** When this feature is turned ON, the terminal sends a notification message to a remote Triton Connect computer if the amount of cash in the cassette falls below the level specified using the SET LOW CASH THRESHOLD function. When this feature is turned OFF, no notification message will be sent.
2. **JOURNAL THRESHOLD.** When this feature is turned ON, the terminal will send a notification message to a remote Triton Connect computer if the number of entries in the journal exceeds the level specified using the SET JOURNAL THRESHOLD function. When this feature is turned OFF, no notification message will be sent.
3. **SCHEDULED JOURNAL.** When this feature is turned ON, the terminal will automatically send all journal data to a remote Triton Connect computer at a time established using the SET SCHEDULED JOURNAL function. When this feature is turned OFF, the journal will not be sent automatically.

The current state of each function is shown as either ON or OFF in the applicable label on the left-hand side of the display. Press the button next to the applicable label to toggle the state of the feature between ON and OFF.

ERROR CONDITIONS:

There are no error conditions directly associated with this function.



9700-SERIES

9705-SERIES

9710-SERIES

9750-SERIES

SET LOW CASH THRESHOLD**FACTORY DEFAULT: 0****ACCESS INSTRUCTIONS:**

1. Select TERMINAL CONFIGURATION from the MANAGEMENT FUNCTIONS menu.
2. Select SET TERMINAL PARAMETERS.
3. Select MORE.
4. Select MORE.
5. Select ALARM THRESHOLDS.
6. Select SET LOW CASH THRESHOLD.

DESCRIPTION:

This function allows you to enter the number of bills that will act as a low cash threshold. When the number of bills in the cassette drops below the value set in this function, the terminal will automatically send a notification message to a remote Triton Connect computer.

To ensure the accuracy of the threshold, make sure to use the ENTER QTY. IN CASSETTE function after replenishing the cash in the cassette.

ERROR CONDITIONS:

There are no error conditions directly associated with this function.

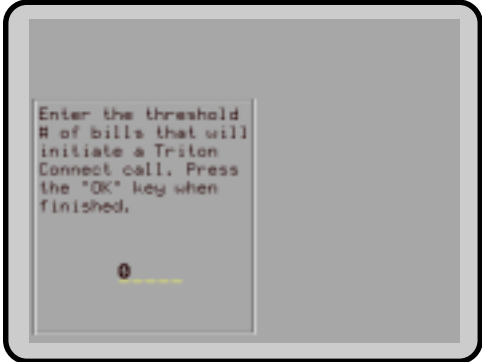

Enter the threshold
of bills that will
initiate a Triton
Connect call. Press
the "OK" key when
finished.

0

9700-SERIES

9705-SERIES

9710-SERIES

9750-SERIES

SET JOURNAL THRESHOLD**FACTORY DEFAULT: 0****ACCESS INSTRUCTIONS:**

1. Select TERMINAL CONFIGURATION from the MANAGEMENT FUNCTIONS menu.
2. Select SET TERMINAL PARAMETERS.
3. Select MORE.
4. Select MORE.
5. Select ALARM THRESHOLDS.
6. Select SET JOURNAL THRESHOLD.

DESCRIPTION:

This function allows you to enter the number of journal entries that will act as a threshold. When the number of journal entries rises above the value set in this function, the terminal will automatically contact the remote Triton Connect computer and initiate a transfer of the journal.

ERROR CONDITIONS:

There are no error conditions directly associated with this function.



```
Enter the threshold
# of journal entries
that will initiate
a Triton Connect
call. press the "OK"
key when finished.
```

9700-SERIES

9705-SERIES

9710-SERIES

9750-SERIES

SET SCHEDULED JOURNAL**FACTORY DEFAULT: 0****ACCESS INSTRUCTIONS:**

1. Select TERMINAL CONFIGURATION from the MANAGEMENT FUNCTIONS menu.
2. Select SET TERMINAL PARAMETERS.
3. Select MORE.
4. Select MORE.
5. Select ALARM THRESHOLDS.
6. Select SET SCHEDULED JOURNAL.

DESCRIPTION:

This function allows you to enter the time at which the terminal will automatically contact a remote Triton Connect computer and initiate a transfer of the journal.

ERROR CONDITIONS:

There are no error conditions directly associated with this function.



Enter the hour in 24
hour format, during
which journal data
will be reported
to Triton Connect.

_:00

9700-SERIES

9705-SERIES

9710-SERIES

9750-SERIES

BACKGROUND GRAPHICS**FACTORY DEFAULT: OFF****ACCESS INSTRUCTIONS:**

1. Select TERMINAL CONFIGURATION from the MANAGEMENT FUNCTIONS menu.
2. Select SET TERMINAL PARAMETERS.
3. Select MORE.
4. Select MORE.
5. Select BACKGROUND GRAPHICS.

DESCRIPTION:

The BACKGROUND GRAPHICS function is used to turn ON or OFF the display of background graphics, and to select the currently displayed background graphic image.

The current state of the BACKGROUND GRAPHICS function is shown as either ON or OFF in the label on the left-hand side of the display. Press the button next to this label to toggle the state of the function between ON and OFF.

To select a background graphic, press the NEXT GRAPHIC button to cycle through the available choices. The background will change to show the currently selected background.

ERROR CONDITIONS:

There are no error conditions directly associated with this function.

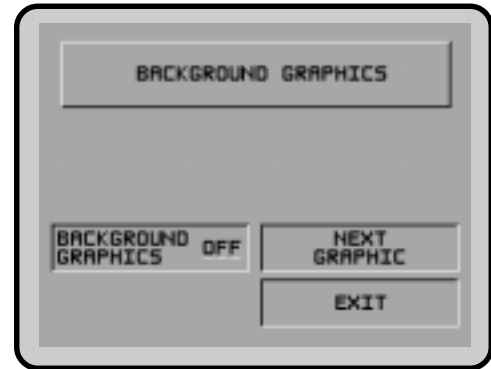

9700-SERIES

9705-SERIES

9710-SERIES

9750-SERIES

VIEW/MODIFY OPTIONS**FACTORY DEFAULT: N/A****ACCESS INSTRUCTIONS:**

1. Select TERMINAL CONFIGURATION from the MANAGEMENT FUNCTIONS menu.
2. Select SET TERMINAL PARAMETERS.
3. Select MORE.
4. Select MORE.
5. Select VIEW/MODIFY OPTIONS.

DESCRIPTION:

The VIEW/MODIFY OPTIONS FUNCTION provides access to terminal parameters for setting the following:

1. ACTIVATE (A selected feature.
2. DEACTIVATE (A selected feature.
3. SELECT FEATURE NUMBER

ERROR CONDITIONS:

There are no error conditions directly associated with this function.



9700-SERIES

9705-SERIES

9710-SERIES

9750-SERIES

ACTIVATE**FACTORY DEFAULT: N/A****ACCESS INSTRUCTIONS:**

1. Select TERMINAL CONFIGURATION from the MANAGEMENT FUNCTIONS menu.
2. Select SET TERMINAL PARAMETERS.
3. Select MORE.
4. Select MORE.
5. Select VIEW/MODIFY OPTIONS.
6. Choose ACTIVATE.

DESCRIPTION:

To activate a FEATURE an activation code must be obtained from the Triton Systems, Inc., Technical Support Department. When calling Triton Systems Inc., you will be asked to provide the serial number that is displayed on the FEATURE 00 SERIAL NUMBER screen.

Once the activation code is obtained, select the ACTIVATE option from the FEATURE 00 Menu to display the FEATURES 00 SERIAL NUMBER screen. Enter the activation code into the terminal while the FEATURE 00 SERIAL NUMBER screen is displayed. Press <OK>. If the activation code is correct, a screen informing you that the terminal must be reset to activate the feature is displayed. Reset the terminal by depressing the RESET switch on the card cage or cycling the Main Power Switch on the Power Supply from ON to OFF to ON.

If the activation code is entered incorrectly, the terminal will beep 4 times and return to the FEATURE 00 Menu.

ERROR CONDITIONS:

There are no error conditions directly associated with this function.



9700-SERIES

9705-SERIES

9710-SERIES

9750-SERIES

DEACTIVATE**FACTORY DEFAULT: N/A****ACCESS INSTRUCTIONS:**

1. Select TERMINAL CONFIGURATION from the MANAGEMENT FUNCTIONS menu.
2. Select SET TERMINAL PARAMETERS.
3. Select MORE.
4. Select MORE.
5. Select VIEW/MODIFY OPTIONS.
6. Choose DEACTIVATE.

DESCRIPTION:

To DEACTIVATE a Feature select the DEACTIVATE option from the FEATURE menu. When DEACTIVATE is selected a confirmation screen ("ARE YOU SURE?") is displayed. Select YES, CONTINUE on the confirmation screen and the FEATURE Menu will be displayed indicating Feature 00 "IS NOT ACTIVE" .

Selecting the NO, CANCEL option when "ARE YOU SURE?" is displayed will return the display to the FEATURE main menu.

ERROR CONDITIONS:

There are no error conditions directly associated with this function.

ARE YOU SURE?

NO. CANCEL

YES. CONTINUE

9700-SERIES

9705-SERIES

9710-SERIES

9750-SERIES

SELECT FEATURE NUMBER**FACTORY DEFAULT:** N/A**ACCESS INSTRUCTIONS:**

1. Select TERMINAL CONFIGURATION from the MANAGEMENT FUNCTIONS menu.
2. Select SET TERMINAL PARAMETERS.
3. Select MORE.
4. Select MORE.
5. Select VIEW/MODIFY OPTIONS.
6. Choose SELECT FEATURE NUMBER.

DESCRIPTION:

Selects the feature number to examine or to activate/deactivate. For example, entering the numbers "00" selects the Triton Connect feature. The current status of the feature will be displayed. Use the ACTIVATE and DEACTIVATE functions as appropriate to change the status of the selected feature.

ERROR CONDITIONS:

There are no error conditions directly associated with this function.



9700-SERIES

9705-SERIES

9710-SERIES

9750-SERIES

DATE / TIME FUNCTIONS**FACTORY DEFAULT: N/A****ACCESS INSTRUCTIONS:**

1. Select TERMINAL CONFIGURATION from the MANAGEMENT FUNCTIONS menu.
2. Choose DATE / TIME FUNCTIONS.

DESCRIPTION:

This screen provides a menu of functions related to configuration of date and time parameters for the Cash Dispenser:

1. SET DATE FORMAT. This option allows you to choose between a DD/MM/YY and a MM/DD/YY date format the terminal will use when printing receipts and other reports.
2. SET DATE / TIME. This option enables you to configure the actual date and time the terminal uses when printing receipts and other reports.

ERROR CONDITIONS:

There are no error conditions directly associated with this function.



9700-SERIES

9705-SERIES

9710-SERIES

9750-SERIES

SET DATE FORMAT**FACTORY DEFAULT: MM/DD/YY****ACCESS INSTRUCTIONS:**

1. Select TERMINAL CONFIGURATION from the MANAGEMENT FUNCTIONS menu.
2. Choose DATE / TIME FUNCTIONS.
3. Choose SET DATE FORMAT.

DESCRIPTION:

This function provides a way to change the date format the terminal uses when printing a date field on receipts and reports. Press the button next to the desired option to activate that format.

ERROR CONDITIONS:

There are no error conditions directly associated with this function.



9700-SERIES

9705-SERIES

9710-SERIES

9750-SERIES

SET DATE / TIME**FACTORY DEFAULT: N/A****ACCESS INSTRUCTIONS:**

1. Select TERMINAL CONFIGURATION from the MANAGEMENT FUNCTIONS menu.
2. Choose DATE/TIME FUNCTIONS.
3. Choose SET DATE / TIME

DESCRIPTION:

The Cash Dispenser contains an internal clock that maintains the date and time, even when power is disconnected from the unit.

Press SET DATE to begin the date entry process. Press SET TIME to begin the time entry process.

ERROR CONDITIONS:

There are no error conditions directly associated with this function.

DATE/TIME SET

06/03/97
12:40:57 PM

SET DATE-->

SET TIME-->

EXIT->

9700-SERIES

9705-SERIES

9710-SERIES

9750-SERIES

SET DATE**FACTORY DEFAULT: N/A****ACCESS INSTRUCTIONS:**

1. Select TERMINAL CONFIGURATION from the MANAGEMENT FUNCTIONS menu.
2. Choose DATE/TIME FUNCTIONS.
3. Select SET DATE / TIME.
4. Select SET DATE.

DESCRIPTION:

Press SET DATE to begin the date entry process. The date is entered in the form 'MM/DD/YY' (month, day, year). Do not enter the '/' characters separating the fields, just the fields themselves. Press CLEAR to erase everything and start over. Press the BACKSPACE key to back up and erase a single character. Press QUIT to escape without doing anything. Press SET DATE to load the entered date into the clock.

The Cash Dispenser will not let you enter an invalid number for hours or minutes. The clock will properly handle the rollover to the year 2000.

ERROR CONDITIONS:

There are no error conditions directly associated with this function.

SET DATE

```

                                     BACKSPACE-->
MM/DD/YY                             CLEAR-->
                                     QUIT-->
                                     SET DATE-->

```

9700-SERIES

9705-SERIES

9710-SERIES

9750-SERIES

SET TIME**FACTORY DEFAULT: N/A****ACCESS INSTRUCTIONS:**

1. Select TERMINAL CONFIGURATION from the MANAGEMENT FUNCTIONS menu.
2. Choose DATE/TIME FUNCTIONS.
3. Select SET DATE / TIME.
4. Select SET TIME.

DESCRIPTION:

The time is entered in the form 'HH:MM:SS' (hours, minutes, seconds). Do not enter the ':' characters separating the fields, just the fields themselves. Press CLEAR to erase everything and start over. Press the BACKSPACE key to back up and erase a single character. Press QUIT to escape without doing anything. Press SET TIME to load the entered time into the clock.

The Cash Dispenser will not let you enter an invalid number for hours or minutes. The clock will properly handle the rollover to the year 2000.

ERROR CONDITIONS:

There are no error conditions directly associated with this function.

SET TIME

PRESS 2 FOR AM OR 7 FOR PM

BACKSPACE-->

HH:MM:SS XM

CLEAR-->

QUIT-->

SET TIME-->

9700-SERIES

9705-SERIES

9710-SERIES

9750-SERIES

TRANSACTION TYPES**FACTORY DEFAULT: ON****ACCESS INSTRUCTIONS:**

1. Select the TERMINAL CONFIGURATION option from the MANAGEMENT FUNCTIONS screen.
2. Select TRANSACTION TYPES.

DESCRIPTION:

This function allows you to turn on or off the availability of the two transaction types: TRANSFERS and BALANCE INQUIRIES. When a transaction type is turned ON, the terminal will provide that option to the customer. When a transaction type is turned OFF, the selected transaction type will not be displayed to the customer.

The current state of the transaction type is shown as either ON or OFF in the applicable button label on the display. Press the button next to the label to toggle the state of the transaction type between ON and OFF.

ERROR CONDITIONS:

There are no error conditions directly associated with this function.

PRESS THE BUTTON NEXT TO
THE TRANSACTION TYPE TO
TOGGLE IT ON OR OFF.

TRANSFERS OFF

BALANCE
INQUIRIES OFF

EXIT

9700-SERIES

9705-SERIES

9710-SERIES

9750-SERIES

ACCOUNT TYPES**FACTORY DEFAULT: ON****ACCESS INSTRUCTIONS:**

1. Select the TERMINAL CONFIGURATION option from the MANAGEMENT FUNCTIONS screen.
2. Select ACCOUNT TYPES.

DESCRIPTION:

This function allows you to turn on or off the availability of two account types: SAVINGS and CREDIT CARD. When an account type is turned ON, the terminal will provide that option to the customer. When an account type is turned OFF, the selected account type will not be displayed to the customer.

The current state of the account type is shown as either ON or OFF in the applicable button label on the display. Press the button next to the label to toggle the state of the account type between ON and OFF.

ERROR CONDITIONS:

There are no error conditions directly associated with this function.

PRESS THE BUTTON NEXT TO
THE ACCOUNT TYPE TO
TOGGLE IT ON OR OFF.

SAVINGS	OFF	CREDIT CARD	ON
EXIT			

SECTION 6 - MAINTENANCE

Introduction

This section of the user manual covers preventive and corrective maintenance procedures appropriate for user personnel. The following areas are covered:

1. **Replenishing Receipt Paper.** Describes how to replace a spent receipt paper roll.
2. **Cleaning the Enclosure.** The proper way to clean the ATM housing.
3. **Card Reader Cleaning.** The recommended card reader cleaning technique.
4. **Card Reader Problems.** Servicing card reader problems.
5. **Communication Problems.** Servicing communications-related problems.

IMPORTANT

Only qualified service personnel are authorized to repair or service the terminal. Should a malfunction occur DO NOT attempt to service the unit yourself! Contact your service provider!

Replenishing the Receipt Paper

NOTE: This operation can be completed with the AC Power applied to the Cash Dispenser

1. This operation can be completed with the power on. Open the top of the cash dispenser by unlocking the control panel and pulling the hinged door forward.

WARNING

The control panel uses a pneumatic piston to prevent the panel from extending too far when opening and from being closed too quickly. In the unlikely event of the pneumatic piston not functioning properly, carefully lower and raise the panel by hand, to prevent damage to the equipment!

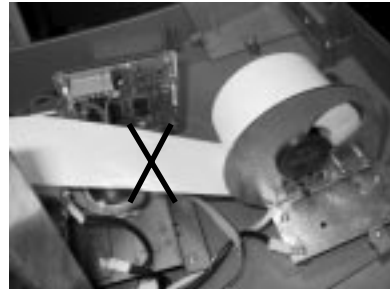

Figure 6-1. Cut any paper between the roll and the printer feed path with scissors.



Figure 6-2. The PAPER FEED BUTTON.



Figure 6-3A. Paper Spool in its normal operating position.

2. If paper remains on the roll, cut the paper between the roll and the printer with a pair of scissors, as shown in Figure 1.
3. Use the RECEIPT PRINTER PAPER FEED BUTTON (Figure 6-2) to feed the paper through the paper path until all paper comes out the front of the printer.

WARNING

Do not pull the paper backward through the printer. This may leave paper fragments that can cause paper jams.

4. Push the paper spool (or partial roll of paper) from its location in Figure 6-3A to the position shown in Figure 6-3B.
5. Remove the paper spool from the paper support bracket by pulling the slotted small end of the spool out of bracket.
5. Remove the tab securing the end of the new paper roll to itself. Use scissors to cut off all of the paper up to and including the glue tab. Insert the paper spool into the new roll of paper (as shown in Figures 6-4A and 6-4B). Use a 6-inch roll of 60-mm wide thermal paper. Be sure the paper spool is inserted so that the paper will feed from the top of the roll when it is installed on the paper bracket.
6. Place the paper roll and paper spool back on the paper bracket by sliding the small slotted end of the spool into the large hole in the bracket as shown in Figure 6-5A. **Note that the paper feeds from the bottom of the roll.** Push the paper and spool into the operating position to lock them in place as seen in Figure 6-5B.
7. Once the paper roll and spool are installed on the paper bracket, take the end of paper roll and feed it into the printer path paper entrance, as shown in Figure 6-6. **Note that the paper feeds from the bottom of the roll.**
8. Once the paper is fed into the paper path entrance, the printer will activate and automatically feed the paper through the printer and out the exit. See Figure 6-7.
9. Close and lock the Cash Dispenser.

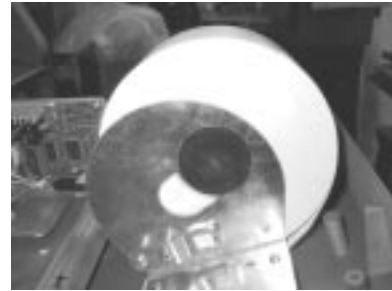

Figure 6-3B The Paper Spool in position for removal.



Figure 6-4A. The paper and paper spool.



Figure 6-4B. Spool inserted into the roll of paper.



Figure 6-5A. Placing the paper roll and spool on the paper bracket.

Cleaning the Enclosure

The Cash Dispenser front panel is highly durable, resisting scratches and finger smudges. However, occasional cleaning of the front panel and the plastic enclosure may be desirable. A soft dry or slightly damp cloth may be used for cleaning. For best results, use a weak solution of a mild detergent and water.

WARNING

Avoid using abrasive cleaners on any surface of the terminal. Do not spray cleaner liquids directly on the unit.

Cleaning the Display

The Liquid Crystal Display (LCD) on the front of the cash dispenser has a plastic protective window that should be cleaned only with a SOFT cloth, dampened with a weak solution of a mild detergent and water.

WARNING

Do not use any abrasive cleaners on the window, as it will scratch. Do not spray liquids onto the screen, as they may run down inside the unit and cause damage.

Card Reader Cleaning

Special cleaning cards are available for proper maintenance of the card reader. The reader should be cleaned at least once a month by inserting and removing a cleaning card, as shown in Figure 6-8. It may be necessary to clean the card reader more often in locations that see heavy usage.



Figure 6-5B. Paper roll and spool in place for operation.



Figure 6-6. Feeding paper into the printer.



Figure 6-7. A new roll of paper installed on the Printer.

Card Reader Problems

The following procedures provide help in recovering from card reader problems.

Can't Read Customer Card

1. Reset the ATM. If the problem still exists, continue with next step.
2. Access Management Functions main menu.
3. Select the DIAGNOSTICS option. Select the MORE DIAGNOSTICS option.
4. Select the SCAN CARD option.
5. Insert and remove an ATM card. If no error message is received, but card still can't be read, contact your service provider. If an error message is received, continue with the next step.
6. Open the ATM control panel. Remove and reconnect the data cable (ribbon-style cable) on the card reader. Close the ATM control panel.
7. Reset the ATM. Try to read a card. If the problem still exists, contact your service provider.

Can't Insert Card Fully

1. Open the ATM control panel to allow light to shine through the card reader slot. Examine the slot from the rear of the card reader.
2. If a foreign object is discovered, try to dislodge it. Use a thin, smooth strip of cardboard or wood (such as a tongue depressor) to remove the obstruction.
3. Close the ATM control panel. Test the card reader, If a card still cannot be fully inserted contact your service provider.



Figure 6-8. Use the cleaning cards on a monthly basis to maintain effective card reader operation.

Communication Problems

Follow these steps to recover from "System Unavailable" and "Communication Error" conditions.

1. Reset the ATM. If the problem still exists, continue with next step.
2. Open the ATM control panel. Plug the base unit of a telephone (NOT the handset) into the phone jack on the third card from the top in the card cage.
3. Listen for a dial tone. If there is a dial tone, unplug the telephone. Close the ATM control panel. Contact your service provider.
4. If there is no dial tone, plug the telephone into the wall jack for the ATM phone line. If there is no dial tone, there is a facility phone line problem. Contact your telephone service provider for assistance.

SECTION 7 - JOURNAL ENTRIES

JOURNAL ENTRIES

Journal entries are printed on a per transaction basis. Each new entry begins with a blank line. The following is an example of a typical journal entry. In the case of a communications error, most of this information is omitted and an error code would be printed.

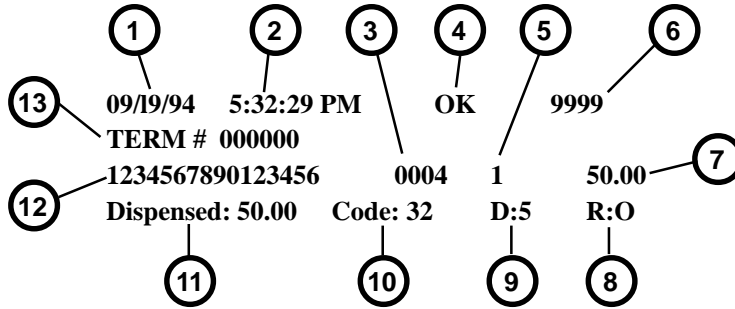

JOURNAL ENTRIES	
#	TYPE
1	Date
2	Time
3	Authorization Number
4	Communication Status
5	Transaction Type*
6	Sequence Number
7	Amount Requested
8	Number of Reject Events
9	Number of Bills Dispensed
10	Dispenser Error Code**
11	Amount Dispensed
12	Account Number
13	Terminal ID Number

* Transaction Types are described in the table on the next page.

** Dispenser Error Codes are described in Section 8, Error Recovery, in the operations manual.

TRANSACTION TYPES	
Transaction Code	Transaction Type
0	Invalid Transaction Type
1	Withdrawal from Checking
2	Withdrawal from Savings
3	Withdrawal from Credit Card
4	Transfer from Checking to Savings
5	Transfer from Saving to Checking
6	Transfer from Credit Card to Checking
7	Transfer from Credit Card to Savings
8	Balance Inquiry Checking
9	Balance Inquiry Savings
10	Balance Inquiry Credit Card
11	Reversal
12	Non-Cash Withdrawal from Checking
13	Non-Cash Withdrawal from Savings
14	Non-Cash Withdrawal from Credit Card
15	Coupon
16	PIN Change

SECTION 8 - ERROR RECOVERY

Introduction

This section of the operation manual describes how user personnel can respond to Cash Dispenser error conditions.

Error Codes / Recovery Procedures

The Cash Dispenser operating system determines the operational status of each of its components by routinely performing a system status check. A status check is performed:

1. During power up.
2. Once every forty seconds while the dispenser is not in use.
3. Before leaving the Management Functions main menu screen.
4. After every transaction.

An error detected during a status check will place the dispenser in an "OUT OF SERVICE" mode of operation and display the messages shown in Figure 8-1 on the LCD display screen.

Many error conditions require the assistance of a qualified service technician to return the Cash Dispenser to normal operation. But there are some actions that the end user can perform to confirm the existence of a problem or correct simple problems.

Table 8-1, Error Codes / Recovery Procedures, provides a list of error conditions that can cause the Cash Dispenser to enter an "OUT OF SERVICE" condition. The table, which spans pages 4 through 7, lists the error codes, a description of each error message and provides a number reference to a recommended recovery procedure that suitable for non-service personnel to perform. The recommended recovery procedures themselves are listed on pages 8 through 21.

Many of the procedures direct you to RESET the Cash Dispenser as the first step. This action may be all that is necessary to clear the error indication. In other cases further actions may be necessary. If necessary, you will be told to contact your service provider.

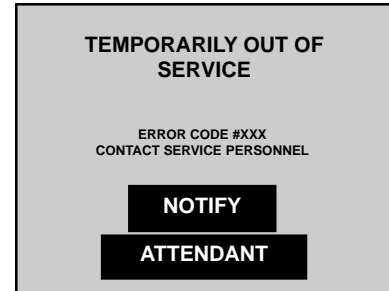

Fig. 8-1. The OUT OF SERVICE screen is displayed if the terminal detects an error condition.

Resetting the Cash Dispenser

In the "OUT OF SERVICE" mode of operation the dispenser will not respond to any inputs to the keypad or card reader.

Try to return the dispenser to normal operation by performing a RESET. To do this, open the top enclosure access door (see CAUTION) and turn the AC Power Switch OFF for a few seconds, then turn it back ON.

After resetting the Cash Dispenser, the RESET ERROR/MANAGEMENT Menu (refer to Figure 8-2.) is displayed on the LCD display screen. This menu allows you to perform two actions:

1. Enter MANAGEMENT mode.
2. RESET the error that caused the OUT OF SERVICE condition.

After selecting the RESET ERROR option, and if no additional error conditions exist, the CUSTOMER WELCOME screen should appear. At this point one further step is usually recommended to confirm that the dispenser is working normally, and that is to perform a TEST DISPENSE. The success of this operation is usually a good indication that the overall dispenser control system and dispensing mechanism are working normally.

It is possible that more than one error condition exists. In these cases, after resetting the original error message (or after performing a TEST DISPENSE) a different error message may be displayed. Address each error message according to the instructions given in Table 8-1, until all problems have been corrected and the Cash Dispenser has been restored to normal operation, or you are instructed to contact your service organization.

Miscellaneous Error Codes

Table 8-2, Miscellaneous Error Codes, lists miscellaneous error codes not included in Table 8-1, Error Recovery Procedures. It is recommended that troubleshooting of these error conditions be coordinated through your service provider.

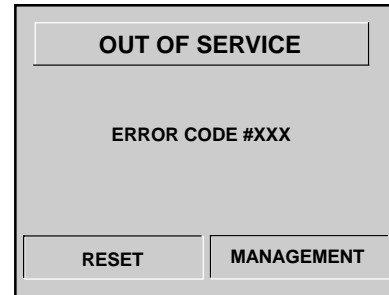

Fig. 8-2. This screen appears after resetting the terminal in an OUT OF SERVICE condition.

ERROR CODES / RECOVERY PROCEDURES						
Error Code	9700+	9705+	9710+	9750+	Meaning	Recovery Procedure
33	X		X		Feed Failure	2
34	X		X		Mistracked note at feed	2
35	X		X		Mistracked note at double detect	2
36	X		X		Mistracked note at exit	2
37	X		X		Note too long at exit	2
38	X		X		Blocked exit	2
39	X		X		Too many notes	2
42	X		X		Timing wheel error	1
44	X		X		Bad roller profile	1
45	X		X		Diverter error	1
46	X		X		Exit quantified	1
47	X		X		Note missing at double detect	2
48	X	X	X		Reject rate exceeded	2
49	X		X		Jam at exit	2
50	X		X		Interference recovery	2
51	X	X	X		Suspect exit accountancy	2
52	X		X		Ram error	1
53	X		X		Eprom error	1
54	X		X		Operation timeout	1
55	X		X		Ram corruption	1
56	X		X		Link error	1
95				X	Multiple cassettes of same type installed	11
101		X			Error (2 sec. Timeout waiting for Pick)	2
102		X			Error (Pick motor over-current)	2
103		X			Thickness sensor unstable	1
104		X			Unable to clear width sensors during reject	2
105		X			Insufficient notes to learn	2
106		X			FIFO error	2
107		X			Suspect reject accountancy	2
109		X			Timeout at exit sensor	2
110		X			Trailing edge timeout at exit	2
111		X			Diverter timeout	1
112		X			Timeout waiting for leading edge at reject	1
113		X			Timeout waiting for trailing edge at reject	1
114		X			Exit blocked during purge	2
115		X			Diverter timeout on purge	1
118		X			Exit sensor blocked on start of dispense or learn	2
119		X			Diverter in dispense position on start of dispense or learn	2
120		X			Reject Cassette not present	2
121		X			Note Cassette not present	2
122		X			Unexpected note at exit	2

ERROR CODES / RECOVERY PROCEDURES						
Error Code	9700+	9705+	9710+	9750+	Meaning	Recovery Procedure
124		X			Diverter moved to exit position during Reject/Purge	1
125		X			Initial status check failed	2
126		X			Diverter moved to reject position during dispense	1
128	X	X	X	X	Error in reply from dispenser	1
129	X	X	X	X	Dispenser not responding	1
130	X	X	X	X	No acknowledge from dispenser	1
131	X	X	X	X	No CTS (Ready) from dispenser	1
132	X	X	X		Status reported bad double detect in previous dispense	1
133	X	X	X	X	5 volts not present from dispenser	1
134	X	X	X		Status reported exit blocked	9
135	X	X	X		Status reported feed sensor blocked	9
136	X	X	X		Modem initialization failed	1
138	X	X	X		Print failure to receipt	4
139	X	X	X	X	Print controller not responding	4
140	X	X	X	X	Time out waiting for printer to be ready	4
141	X	X	X	X	Status reported paper jam	4
142	X	X	X	X	Dispenser returned bad command error	1
143	X	X	X	X	PTDF Error	1
144	X	X	X	X	Security module not responding	1
145	X	X	X	X	Security module bad reply	1
146	X	X	X	X	Electronic journal not responding	1
147	X	X	X	X	Electronic journal bad reply	1
148	X	X	X	X	Electronic journal write failed	1
149	X	X	X	X	Electronic journal read failed	1
150	X	X	X	X	Electronic journal status failed	1
151	X	X	X	X	Electronic journal full	12
152	X	X	X	X	Electronic journal corrupt	1
153	X	X	X	X	Electronic journal download failed	1
154	X	X	X	X	Electronic journal bad	1
155	X	X	X	X	EJ module failed	1
156	X	X	X	X	No Cassette	8
157	X	X	X	X	EJ erase failed	1
158	X	X	X		EJ format failed	1
159	X	X	X	X	EJ test feature failed	1
161				X	EJ clear feature failed	1
162	X	X	X	X	EJ get serial number failed	1
163	X	X	X		Terminal did not answer Triton Connect	1
164	X	X	X		Terminal did not return call to Triton Connect	1
165	X	X	X		EJ not present	1

ERROR CODES / RECOVERY PROCEDURES						
Error Code	9700+	9705+	9710+	9750+	Meaning	Recovery Procedure
166	X	X	X		Bad dispenser	1
167	X	X	X	X	Reported Low Cash to Triton Connect	5
168	X	X	X	X	Software Download to Terminal Failed	1
182	X	X	X	X	Currency cassette low	5
183	X	X	X	X	Receipt printer paper low	10
185	X	X	X	X	Phone number not configured	3
186	X	X	X	X	Bill size not configured correctly	3
187	X	X	X		Maximum withdrawal not configured correctly	3
188	X	X	X	X	Communications key not configured	3
189	X	X	X	X	Terminal ID not configured	3
190	X	X	X	X	Master key not configured	3
191	X	X	X		Feed failure	2
192	X	X	X	X	CD communications error	1
193				X	The Baud rate setting for the EJ failed	13
194				X	An attempt to dispense bills is being made when the cassettes are not locked	14
195	X	X	X	X	Receipt Printer Out of Paper	10
196	X	X	X	X	Card Reader Error	1
203	X	X	X	X	SPED keypad is not replying to main board	1
205	X	X	X	X	SPED keypad reported tamper condition	1
206	X	X	X	X	SPED could not perform a successful command within SPED_MAX_ATTEMPTS tries	1
207	X	X	X	X	SPED Not Detected	1
209				X	Check Number of Notes Delivered command failed	1
210				X	The Dispenser Type is unknown	1
300				X	Successful command	
301				X	Low level	5
302				X	Empty Cassette	5
303				X	Lifts are down	6
304				X	Rejected Notes	1
305				X	Wrong Count	1
306				X	Failure to Feed	1
307				X	Transmission Error	1
308				X	Illegal Command or Command Sequence	1
309				X	Jam in Note Qualifier	1
310				X	Feed Cassette Not Present	6
311				X	Configuration Record Size Invalid	1
312				X	No Notes Retracted	1
313				X	Cassette Hopper Map Invalid	1
314				X	Cannot Resolve Dispense Count	1
315				X	Reject Cassette Not Properly Installed	6

ERROR CODES / RECOVERY PROCEDURES						
Error Code	9700+	9705+	9710+	9750+	Meaning	Recovery Procedure
316				X	Delivery Failure	1
317				X	Reject Failure	1
318				X	Too Many Notes Requested	1
319				X	Jam in Note Transport	1
320				X	Reject Cassette Almost Full	7
321				X	Cassette Data Corrupted	1
322				X	Main Motor Failure	1
323				X	Dispense Count Check Error	1
325				X	Note Qualifier Faulty	1
326				X	Cassette exit sensor failure	1
327				X	Shutter Failure	1
329				X	Notes in Delivery Throat	1
330				X	Communications Time-out	1
332				X	Cassette May have been Changed	1
333				X	Reject Cassette Full	1
339				X	Error in Throat	1
343				X	Sensor Error or Sensor Covered	1
348				X	NMD Internal Failure/Data Corrupted	1
349				X	Cassette Lock Faulty	1
350				X	Jam in Note Stacker	1
351				X	Module Need Service	1
353				X	No Message To Resend	1
356				X	Error in Note Transport	2

ERROR RECOVERY PROCEDURE**1**

1. Reset the Cash Dispenser.
2. If the error clears, perform a Test Dispense.
3. If the dispense works, place the unit back in service.
4. If the test dispense does not work, or the error occurs again, contact your service provider.

This Procedure applies to the following error codes:

52, 53, 54, 55, 56, 128, 129,
130, 131, 132, 133, 136,
142, 143, 144, 145, 146,
147, 148, 149, 150, 152,
153, 154, 155, 157, 158,
159, 161, 162, 163, 164,
165, 166, 168, 192, 196,
203, 205, 206, 207, 209,
210, 304, 305, 306, 307,
308, 309, 311, 312, 313,
314, 316, 317, 318, 319,
321, 322, 323, 325, 326,
327, 329, 330, 332, 333,
339, 343, 348, 349, 350,
351, 353

ERROR RECOVERY PROCEDURE**2**

1. Turn off the Cash Dispenser and open the security container.
2. Inspect the dispensing mechanism feed path for jammed currency and currency sticking together. Clear the feed path as needed.
3. Remove and inspect the cassette(s) for damage that could prevent proper dispensing. Also, make sure the currency is fit for dispensing. If there is no currency in the cassette(s), or the currency level is too low, fill the cassette(s) and reinstall.
4. Close and lock the security container. Reset the Cash Dispenser.
5. If the error clears, perform a Test Dispense.
6. If the dispense works, place the unit back in service.
7. If the test dispense does not work, or the error occurs again, contact your service provider.

This Procedure applies to the following error codes:

33, 34, 35, 36, 37, 38, 39,
47, 48, 49, 50, 51, 80, 81,
191, 356

ERROR RECOVERY PROCEDURE

3

Refer to your ATM Operations Manual for procedures on checking and setting this parameter.

This Procedure applies to the following error codes:

185, 186, 187, 188, 189, 190

ERROR RECOVERY PROCEDURE**4**

1. Unlock and open the Cash Dispenser control panel and turn power OFF.
2. Check the paper feed path. Ensure no cables or ground wire is impeding paper path between paper roll and printer.
3. Cut paper between paper roll and printer with a set of scissors. Open printer by loosening the thumb screw on side of printer mechanism. Lift printer head and gently pull paper from front of printer. **NEVER PULL PAPER BACKWARD FROM THE REAR OF PRINTER.**
4. Check the blue tension lever located opposite side of printer. Blue lever should be actuating (touching) a clear plastic micro-switch that has white wires running to it. If it isn't, move lever until it's actuating switch. (Blue lever gets moved inadvertently sometimes when printer is opened)
5. Turn power ON. With printer still open, touch manual feed button and watch roller turn. Inspect for any paper shreds in roller.
6. Close printer and tighten thumb screw. Feed paper roll into printer. Paper should feed automatically for a short distance. Push manual feed button until receipt paper exits front of control panel.
7. If error is displayed on screen, try resetting error. If error clears, go to Management Functions, enter password, then to Diagnostics. Select **TEST RECEIPT PRINTER** and wait for receipt. If receipt prints, exit back out to Customer screen
8. Other causes may be low or out of paper. See the applicable Operations Manual for paper roll replacement procedure. Also, paper guide on printer bracket must be parallel to printer path entrance, and paper support bracket must be perpendicular to paper path entrance.
9. If the error appears again, call your service provider.

This Procedure applies to the following error codes:

138, 139, 140, 141

ERROR RECOVERY PROCEDURE**5**

1. Turn off the Cash Dispenser and open the security container.
2. Check the currency level in the cassette(s). If there is no currency in the cassette(s), or the currency level is too low, fill the cassette(s) and reinstall.
3. Close and lock the security container. Reset the Cash Dispenser.
4. If the error clears, perform a Test Dispense.
5. If the dispense works, place the unit back in service.
6. If the test dispense does not work, or the error occurs again, contact your service provider.

IMPORTANT NOTE

If the terminal dispenses all of its cash and a cassette has not been refilled with enough cash to position the packer plate far enough from Low Currency switch, the terminal will go into the Error 182 condition when the RESET ERROR key is pressed. To prevent this from occurring, follow these steps:

1. Remove the cassette from the dispenser mechanism.
2. Reset the error.
3. Refill the cassette as necessary and install it in the dispenser mechanism.

This Procedure applies to the following error codes:

167, 182, 301, 302

ERROR RECOVERY PROCEDURE**6**

1. Ensure all cassettes are actually present in the mechanism. If they are, remove and re-install each cassette.
2. Ensure all cassettes are LOCKED into position in the mechanism, using the cassette LOCK/UNLOCK function.
3. Close and lock the security container. Reset the Cash Dispenser.
4. If the error clears, perform a Test Dispense.
5. If the dispense works, place the unit back in service.
6. If the test dispense does not work, or the error occurs again, contact your service provider.

This Procedure applies to the following error codes:

303, 310, 315

ERROR RECOVERY PROCEDURE**7**

1. Remove and empty the Reject Cassette. Reinstall the Reject Cassette.
2. Close and lock the security container. Reset the Cash Dispenser.
3. If the error clears, perform a Test Dispense.
4. If the dispense works, place the unit back in service.
5. If the test dispense does not work, or the error occurs again, contact your service provider.

This Procedure applies to the following error codes:

320

ERROR RECOVERY PROCEDURE**8**

1. Turn off the Cash Dispenser and open the security container.
2. Ensure all cassettes are present. Remove and reinstall the cassettes.
3. Close and lock the security container. Reset the Cash Dispenser.
4. If the error clears, perform a Test Dispense.
5. If the dispense works, place the unit back in service.
6. If the test dispense does not work, or the error occurs again, contact your service provider.

This Procedure applies to the following error codes:

156

ERROR RECOVERY PROCEDURE**9**

1. Turn off the Cash Dispenser and open the security container.
2. Inspect the dispensing mechanism feed path for jammed currency and currency sticking together. Clear the feed path as needed.
3. Close and lock the security container. Reset the Cash Dispenser.
4. If the error clears, perform a Test Dispense.
5. If the dispense works, place the unit back in service.
6. If the test dispense does not work, or the error occurs again, contact your service provider.

This Procedure applies to the following error codes:

134, 135

ERROR RECOVERY PROCEDURE**10**

1. Unlock and open the Cash Dispenser control panel.
2. Check the receipt paper spool. If the paper spool is low or out of paper, replace the paper roll. See the applicable Operations Manual for paper roll replacement procedure.
3. Reset the terminal. If the error clears, place the unit back in service.
4. If the error occurs again, contact your service provider.

This Procedure applies to the following error codes:

183, 195

ERROR RECOVERY PROCEDURE**11**

1. Unlock and open the security container.
2. Check the labels on the cassettes. If a duplicate cassette is installed, replace it with the correct non-duplicate cassette. If necessary, use the INJECT NEW CASSETTE ID procedure to ensure each cassette has a unique ID (A, B, C, or D).
3. Make sure all cassettes are IN SERVICE.
4. RESET the cash dispenser and perform a Test Dispense. If the dispense works, place the unit back in service.
5. If the error occurs again, contact your service provider.

This Procedure applies to the following error codes:

95

ERROR RECOVERY PROCEDURE**12**

1. Archive or Print the journal.
2. Reset the Cash Dispenser.
3. If the error clears, perform a Test Dispense.
4. If the dispense works, place the unit back in service.
5. If the test dispense does not work, or the error occurs again, contact your service provider.

This Procedure applies to the following error codes:

151

ERROR RECOVERY PROCEDURE**13**

1. Turn off the Cash Dispenser and open the security container.
2. Inspect the EJ Module. The EJ should be yellow in color.
3. Close and lock the security container.
4. If the EJ Module is the correct color, reset the Cash Dispenser.
5. If the error clears, perform a Test Dispense.
6. If the dispense works, place the unit back in service.
7. If the test dispense does not work, the error occurs again, or the EJ Module is not yellow in color, contact your service provider.

This Procedure applies to the following error codes:

193

ERROR RECOVERY PROCEDURE**14**

1. Use the Lock/Unlock function to ensure the cassettes are locked.
2. Reset the Cash Dispenser.
3. If the error clears, perform a Test Dispense.
4. If the dispense works, place the unit back in service.
5. If the dispense does not work, or the error occurs again, contact your service provider.

This Procedure applies to the following error codes:

194

TABLE 8-2 - MISCELLANEOUS ERROR CODES

Error/Status Code	Meaning	Recommended Actions
1	Timeout	Contact your service provider for assistance.
3	BGD_NOANSWER	Contact your service provider for assistance.
4	Error in modem data	Contact your service provider for assistance.
6	BGD_NODIALTONE	Contact your service provider for assistance.
7	BGD_BUSY	Contact your service provider for assistance.
10	BGD_LOGON	Contact your service provider for assistance.
11	No connect	Contact your service provider for assistance.
13	BGD_DONE_GOOD	Contact your service provider for assistance.
14	EOT received	Contact your service provider for assistance.
15	Timed out waiting for EOT	Contact your service provider for assistance.
16	Communication problems	Contact your service provider for assistance.
65	Processor not communicating with modem correctly.	Contact your service provider for assistance.

SECTION 9 - CUSTOMER TRANSACTIONS

Introduction

The daily operation of the Cash Dispenser is quite simple and straightforward. Once the terminal has been properly configured (see Section 3, Setup), the only management functions that will be used on a regular basis are the CLOSE and JOURNAL functions (see Section 5, Management Functions).

This section discusses the day-to-day operation of the Cash Dispenser from a customer standpoint.

Customer Transactions

A customer begins a transaction on the Terminal by inserting their ATM card into the card reader of the terminal. The card must be inserted so that the magnetic stripe can be scanned by the card reader's sensor. If the customer inserts the card incorrectly, a warning message will be displayed, accompanied by several beeps to get their attention.

If there is a problem reading a card, make sure it is being inserted correctly. Most problems are the result of inserting the card incorrectly.

Once the card has been read in successfully, a surcharge screen, if applicable, may be displayed (the surcharge screen may be displayed at the end of the customer's transaction selection). The customer must then enter his secret Personal Identification Number, or PIN or code. Once the PIN has been entered, the transaction type and account are selected, and the desired amount of the transaction, if needed. The transaction will be processed, typically in a matter of seconds.

If the transaction was processed successfully, the customer is prompted to retrieve the requested cash (for withdrawal transactions) and/or the applicable transaction receipt, as needed. If the transaction was declined, a short receipt indicating the problem is printed.

Figures 9-1, Transaction Flow shows the sequence of screens and operations that would be presented during typical Withdrawal, Transfer and Balance Inquiry transactions. Table 9-1, Transaction Flow Description, provides an explanation of each step of the sequence shown in Figure 9-1.

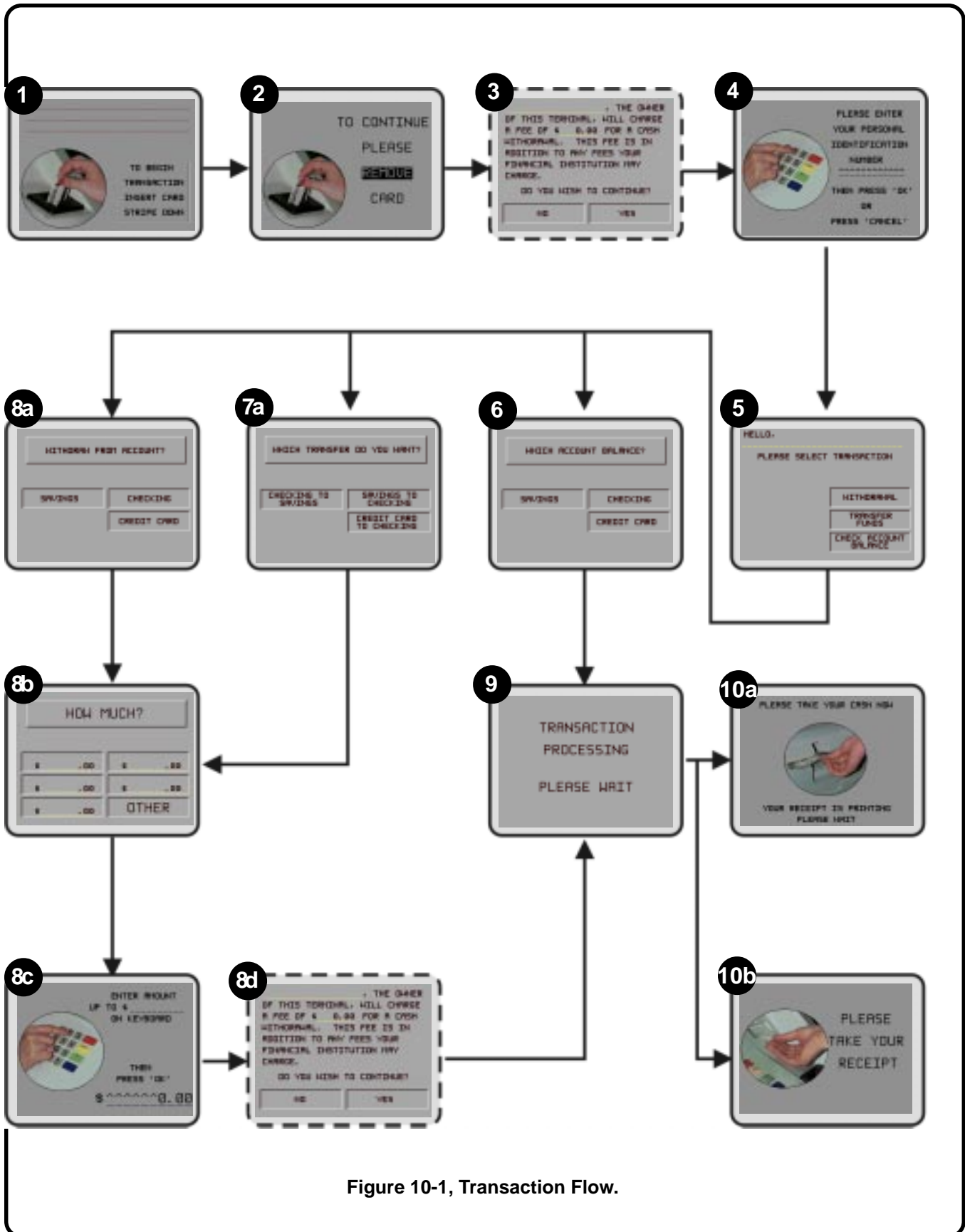

Figure 10-1, Transaction Flow.

TABLE 9-1 - TRANSACTION FLOW DESCRIPTION

STEP	DESCRIPTION
1	Welcome screen prompts to INSERT a CARD to begin a transaction.
2	Screen prompts user to REMOVE the CARD to continue with transaction.
3	If the Surcharge Option is enabled, surcharging is not blocked for this customer card, and the Surcharge Location option is set for Beginning, a Surcharge Message is displayed here.
4	Customer is prompted to enter a Personal Identification Number, or PIN.
5	Customer is prompted to select a Transaction Type. The available transactions will be determined by the Transaction Types settings in Management Functions.
6	If a Balance Inquiry transaction is selected, the customer is prompted to choose the account. The available accounts will depend upon the Account Types settings in Management Functions.
7	If a Transfer transaction is selected, the customer is prompted to choose the transfer accounts. The available accounts will depend upon the Account Types settings in Management Functions.
8A	If a Withdrawal transaction is selected, the customer is prompted to choose the withdrawal account. The available accounts will depend upon the Account Types settings in Management Functions.
8B	The customer is given an opportunity to select a Fast Cash withdrawal or transfer amount, as applicable. If OTHER is selected, the customer can enter a different amount.
8C	If OTHER was selected on the Fast Cash amounts screen, this screen will offer the customer a way to enter a custom withdrawal or transfer amount, as applicable.
8D	If the Surcharge Option is enabled, surcharging is not blocked for this customer card, and the Surcharge Location option is set for Ending, a Surcharge Message is displayed here.
9	"Transaction Processing" message appears during processing interval.
10A	If the transaction was a withdrawal transaction and was successful, the customer is prompted to take the cash from the currency slot. A transaction receipt will print
10B	If the transaction was a withdrawal, transfer, or balance inquiry transaction and was successful, the customer is prompted to take the transaction receipt. A thank-you message may be displayed briefly, after which the Welcome screen is displayed. The Cash Dispenser is ready for the next transaction.

Voice-Enabled Transactions

The terminal provides voice feedback via an integrated output jack, enabling sight-impaired users to plug in a set of headphones and receive spoken instructions to assist them in using the Cash Dispenser. Figure 9-2, Headphone Jack Location, shows the location of the headphone jack on the Cash Dispenser.



Figure 9-2, Headphone Jack Location.

A raised symbol helps a user locate the headphone jack. The Cash Dispenser will automatically detect when a headphone has been plugged into the jack, and will immediately switch into voice mode. Initially, a brief spoken tutorial will orientate the customer to the Cash Dispenser control panel interface. Once the customer begins a transaction, spoken prompts will provide feedback and guide the customer through the successful accomplishment of the transaction.

APPENDIX A - MECHANICAL LOCK

About the Dial

There are two marks on the dial ring (see drawing). The index at the top is used for opening the lock, The index 30 degrees to the left is used only when changing the combination.

The dial should always be turned slowly and evenly. A revolution is counted each time the selected number is aligned with the opening index. **DO NOT TURN THE DIAL BACK TO COMPENSATE FOR OVER DIALING A NUMBER.** If, when dialing the combination, any number is turned beyond the index, the entire sequence must be repeated.

Locks are shipped on a factory setting of '50'. To unlock, turn the dial to the left (counterclockwise) **FOUR** turns, stopping on '50'.

Then, turn the dial to the right until the bolt is retracted.

Unlocking 3-Number Combinations (For Example, "50-25-50")

1. Turn the dial to the **LEFT**, stopping when '50' is aligned with the opening index, the **FOURTH** time.
2. Turn the dial to the **RIGHT**, stopping when '25' is aligned with the opening index, the **THIRD** time.
3. Turn the dial to the **LEFT**, stopping when '50' is aligned with the opening index, the **SECOND** time.
4. Turn the dial slowly to the **RIGHT** until the bolt retracts.

To Lock

Turn the dial to the **LEFT** at least four full revolutions.

Changing the Combination

Select three new numbers. **DO NOT** use any number between 1 and 20 for the last number.

For maximum security, do not use numbers that end in 0 or 5, and do not use numbers in sequence: e.g., '27-48-86' is not as good as '27-86-48". Perform the following steps:

1. Dial the existing combination on the opening index (see steps 1-2-3 above, or the directions for opening when on the factory setting). Open door of container.
2. Dial the existing combination again, using the changing index.

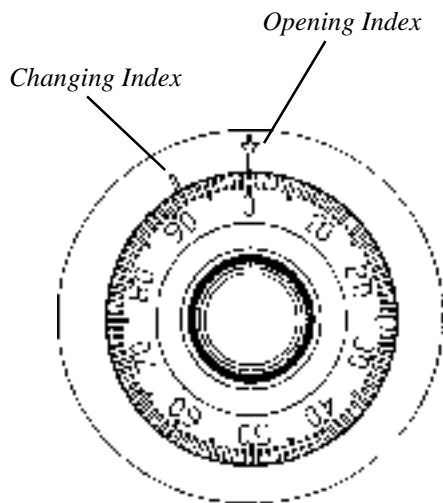

3. With the last number set at the changing index, hold the dial securely and insert the change key in the keyhole in the back of the lock. Make sure the wing is entirely inside the lock and comes to a positive stop (see Figure 1) before turning the key.

*****WARNING*****

NEVER INSERT THE CHANGE KEY IN THE LOCK WHEN THE COVER IS REMOVED. BEFORE TURNING THE CHANGE KEY, MAKE SURE THE WING OF THE KEY IS FULLY INSERTED INTO THE LOCK.

4. Turn key one-quarter turn to the LEFT (see Figure 1). With the change key in this position, set the new combination as follows: turn the dial to the LEFT, stopping when the first number of the new combination aligns with the changing index the FOURTH time.
5. Turn dial to the RIGHT, stopping when the second number is aligned with the changing index, the THIRD time.
6. Turn the dial to the LEFT, stopping when the third number is aligned with the changing index, the SECOND time. Holding the dial in this position, turn the change key back to the RIGHT and remove it. (See Figure 2.) The new combination you have chosen is now set in the lock,

*****CAUTION*****

**BEFORE CLOSING THE UNIT
TRY THE NEW COMBINATION SEVERAL TIMES
USING THE OPENING INDEX.**



Figure 1

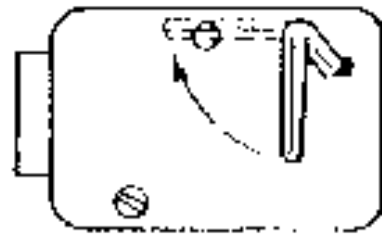

Figure 2

APPENDIX B - ELECTRONIC LOCK

Entering the Combination

The electronic lock combination consists of six digits. Upon arrival, the combination of the lock should already be set at **1-2-3-4-5-6**. After installation of the safe has been completed,

1. Enter the preset combination and check for proper operation. After each keypress, the lock will beep. After the final digit has been entered, the lock will beep twice, and the open period will begin.
2. When a valid combination has been entered, the operator will have approximately **3 seconds** to open the lock.
3. To open the lock, turn the dial clockwise.
4. After the lock is opened, the door latch may be turned and the safe opened.

Changing the Combination

To change the combination of the lock, simply follow these directions.

- Enter **six zeros**.
- Enter the **current** combination. (Initially set at 1-2-3-4-5-6)
- Enter the **new** combination twice.
- The combination is now changed. Enter the new combination to open the lock.

Lockout Feature

The lock includes a **WRONG TRY PENALTY** lockout feature that prevents entry from unauthorized personnel. This feature performs as follows:

- Entry of four consecutive invalid combinations will disable the lock for **5 minutes**.
- During this lockout period, the panel LED will flash every **10 seconds**. During this time no other combination entries will be allowed.
- At the end of the lockout period, if two more consecutive invalid combinations are entered, the **5-minute** lockout period will restart.

Bad Battery/Battery Replacement

If the lock beeps repeatedly while open, or beeps twice and refuses to open, the 9-volt battery, **located in the battery box on the inside of the door**, is weak or dead and needs to be replaced.

Note: If the lock will not operate (i.e. no signal from the panel when a button is pressed) while the door is closed and locked, the battery is dead and the lock must be energized from the two external terminals on the front, right side of the push-button panel.

To energize the lock, connect a 9-volt battery across the external terminals with the negative terminal of the battery facing up. **Continue to hold the battery against the terminals as you enter the combination and open the lock.**

Follow these steps to replace a battery:

1. Open the ATM vault door. If the battery box is visible on the back panel of the door, continue with Step 2, below. **If the battery box is not visible, the bolt-works panel must be removed.** Remove the eight screws from the bolt-works panel on the back side of the door. The battery box will be visible.
2. Pull gently on the front cover of the battery box and slide the cover off.
3. Remove the old battery. Install a new battery and replace the front cover.
4. Verify the lock is working correctly.
5. **If the bolt-works panel was removed in Step 1, replace the panel and secure it in place using the eight installation screws.** Close and lock the ATM vault door.

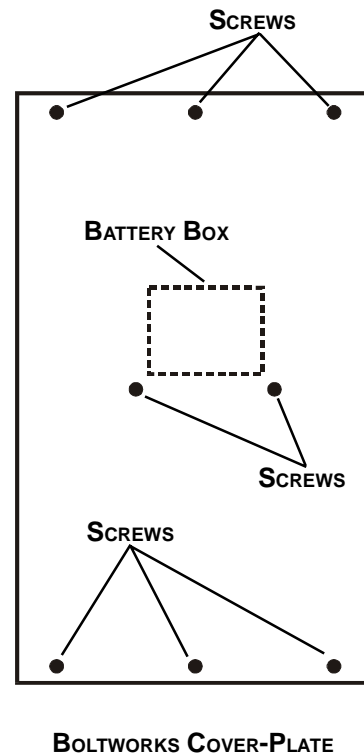

APPENDIX C - WARRANTY POLICY

Notices

Copyright ©2001 - Triton Systems, Inc.; 21405 B Street.; Long Beach, MS 39560 USA

All Rights Reserved

This publication is protected by copyright and all rights are reserved. No part of it may be reproduced or transmitted by any means or in any form, without prior consent in writing from Triton Systems, Inc.

The information in this publication has been carefully checked and is believed to be accurate. However, Triton Systems, Inc. assumes no responsibility for any inaccuracies, errors, or omissions that may be contained in this document. In no event will Triton Systems, Inc. be liable for direct, indirect, special, incidental, or consequential damages resulting from any defect or omission in this manual, even if advised of the possibility of such damages.

In the interest of continued product development, Triton Systems, Inc. reserves the right to make improvements in its documentation and the products it describes at any time, without notice or obligation.

Trademark Acknowledgments

miniATM[™] is a trademark of Triton Systems, Inc.

TRITON SYSTEMS, Inc.**Warranty Statement****Parts Only Limited Manufacturer's Warranty**

Triton Systems, Inc. warrants the components of each Model 97XX Series Cash Dispenser, excluding software and related documentation, against any defect in materials and/or workmanship for a period of 13 months from the shipping date. The additional 30 days are intended to allow for the elapsed time between the shipment of the unit and its installation. If a component fails due to defects in materials and/or workmanship within the warranty period, Triton will furnish a new or refurbished component, at its discretion. Triton shall not be responsible for labor or other costs associated with installing the component; and the failed component shall be returned to Triton at the purchaser's expense. Triton shall not be responsible for misuse or abuse of a unit; and any attempts to remove or deface the serial number or date code on a unit or any component thereof, or any attempt to repair a unit or to repair or replace any component by anyone other than a service technician authorized by Triton shall void this warranty.

Limited Warranty covers normal use. Triton Systems does not warrant or cover damage:

- occurring during shipment of the equipment or components from or to Triton's facilities;
- caused by accident, impact with other objects, dropping, falls, spilled liquids, or immersion in liquids;
- caused by a disaster such as fire, flood, wind, earthquake, lightning, or other acts of God;
- caused by failure to provide a suitable installation environment for the equipment, including but not limited to, faulty wiring in the building in which the equipment is installed, installation in a facility with uncontrolled environmental conditions, failure to provide a dedicated electrical circuit on which the equipment operates, and/or lack of proper earth grounding for the equipment;
- caused by the use of the equipment for purposes other than those for which it was designed;
- resulting from improper maintenance;
- caused by any other abuse, misuse, mishandling, or misapplication.

Under no circumstances shall Triton Systems or its suppliers be liable for any special, incidental, or consequential damages based upon breach of warranty, breach of contract, negligence, strict liability, or any other legal theory. Such damages include, but are not limited to, loss of profits, loss of revenue, loss of data, loss of use of the equipment or any associated equipment, cost of capital, cost of substitute or replacement equipment, facilities or services, down time, purchaser's time, the claims of third parties, including customers, and injury to property.

Disclaimer of Warranties

The warranty stated above is the only warranty applicable to this product. All other warranties, expressed or implied (including all implied warranties of merchantability or fitness for a particular purpose or quality of service), are hereby disclaimed. No oral or written information, or advice given by Triton Systems, its agents or employees shall create a warranty or in any way increase the scope of this warranty.

Other Claims

Shipping Damage

All equipment is shipped FOB, Triton's facilities. The organization or individual who has purchased the equipment assumes responsibility for the equipment once it leaves Triton's facilities.

Should your equipment be damaged in the process of shipment or delivery to your place of destination, we recommend the following course of action:

- If possible, call the shipping company before the driver leaves your delivery site. Make note of the damage on the "receipt of delivery" paperwork. If this is not possible, call them as soon as possible to report the damage.
- Take photographs of the damaged packaging prior to opening the boxes. If this is not possible, make note of key points, such as whether the equipment is on a pallet, if the banding is intact, how the boxes are damaged, etc. Keep all of the packaging for inspection by the shipping company.
- If you unpack the equipment, take photographs of the damaged equipment. If this is not possible, make note of the damages.
- You must file a claim with the shipper for shipping damages immediately after reporting the damages.

Should you specify the carrier, we recommend that you explore with this chosen carrier the policies and procedures regarding shipping damage claims prior to selecting them as your preferred carrier.

If the equipment receives structural damage and is in an un-installable condition, Triton will work with you to arrange for a replacement unit to be shipped as soon as possible. The purchaser will be billed for the replacement unit. Triton's Repair Technicians will repair the damaged unit after it is returned to our facilities. We will credit the purchaser's account for the full purchase price of the damaged unit, minus the cost of returning the unit to "like new" condition. Under no circumstances does Triton authorize anyone to complete structural damage repairs in the field. Therefore, we will not ship primary structural parts, such as a cabinet head or main cabinet body for repair in the field.

Authorized Installation and Service Providers

Triton Systems utilizes several nation-wide and regional authorized third party maintenance providers. All miniATM™ Cash Dispensers must be installed and serviced by service technicians certified by Triton. This includes authorized third party service technicians and technicians who have been factory trained by Triton to service miniATM™ equipment. Installation or repairs attempted by unauthorized service technicians automatically voids the warranty on the product.

Please contact Triton Systems' Technical Services Department at (800) 259-6672 for a list of our third party service providers and/or to obtain information on the requirements and procedures for becoming a certified Triton service technician.

Triton's Technical Services Department

The primary purpose of the Technical Services Department is to provide assistance to customers in the operation, trouble shooting, and repair of equipment manufactured by Triton. A toll-free phone number (1-800-259-6672) is provided for convenience. The Technical Services Department operates to serve our customers. The staff is trained to follow our policies and procedures to ensure fair and uniform treatment of all our customers.

Automated Voice Mail System. Our goal is to have a 'live' person answer 100% of all incoming calls (during regular support hours). On occasion, however, call loads may exceed the capacity of the staff. When this occurs, an automated voice mail system will answer the call, indicate to the caller that all Technical Support Specialists are busy assisting others, and ask the caller to leave detailed information about the nature of the call.

Should it become necessary to leave a voice mail message, the caller should state:

- their name
- the organization for which they work
- the serial number of the equipment they are calling about
- detailed description of the problem that they are experiencing
- phone number where they can be reached, including area code.

As Technical Support Specialists become available, they check for voice mail messages and return calls in the order in which they were received. By providing the information requested in the voice mail, the technician can be prepared when your call is returned. Triton asks you to be patient if you must leave voice mail, and assures you that your call is important to us and that we will respond promptly.

Calls for Service or Repair. Calls for service or repair will be accepted from authorized service technicians only. End users must contact either the sales organization that placed the equipment or an authorized third party service organization to obtain service. The sections that follow describe the policies and procedures that relate to the repair and replacement of malfunctioning equipment.

Questions on Operation of Equipment. Technical support is available to owners of Triton equipment and to qualified service personnel. When calling for help with the configuration or operation of a Triton product, the caller must provide either positive identification as a service technician or the serial number of a Triton terminal. Technical support is provided during normal business hours for the life of the product.

When calling for help with an operational Problem, please have available information pertaining to the nature of the trouble. This includes the type of equipment, examples of what is or is not happening, and the name of the processor that supports your terminal.

All questions pertaining to the settlement of accounts, transaction inquiries, and fund status must be directed to the processor. Triton does not have access to the information needed to answer questions relating to specific transactions.

CONTACT INFORMATION

TRITON SYSTEMS, IN21405 B STREET
21405 B STREET
LONG BEACH, MS 39560

Sales:

(800) 367-7191
(228) 868-1317
(228) 868-0437 FAX

Service:

(800) 259-6672
(228) 868-0859 FAX